

MIN-MAX CONTROLLER OUTPUT CONFIGURATION TO IMPROVE MULTI-MODEL PREDICTIVE CONTROL WHEN DEALING WITH DISTURBANCE REJECTION

Abdul Wahid^{1*}, Arshad Ahmad^{2,3}

¹ *Department of Chemical Engineering, Faculty of Engineering, Universitas Indonesia, Kampus Baru UI Depok, Depok 16424, Indonesia*

² *Department of Chemical Engineering, Faculty of Chemical Engineering, Universiti Teknologi Malaysia, Johor Baru, Johor 81310, Malaysia*

³ *Center of Hydrogen Energy, Institute of Future Energy, Universiti Teknologi Malaysia, Johor Baru, Johor 81310, Malaysia*

(Received: May 2015 / Revised: July 2015 / Accepted: July 2015)

ABSTRACT

A Multiple Model Predictive Control (MMPC) approach is proposed to control a nonlinear distillation column. This control framework utilizes the best local linear models selected to construct the MMPC. The study was implemented on a multivariable nonlinear distillation column (Column A). The dynamic model of the Column A was simulated within MATLAB[®] programming and a SIMULINK[®] environment. The setpoint tracking and disturbance rejection performances of the proposed MMPC were evaluated and compared to a Proportional-Integral (PI) controller. Using three local models, the MMPC was proven more efficient in servo control of Column A compared to the PI controller tested. However, it was not able to cope with the disturbance rejection requirement. This limitation was overcome by introducing controller output configurations, as follows: Maximizing MMPC and PI Controller Output (called MMPCPIMAX). The controller output configurations of PI and single linear MPC (SMPC) have been proven to be able to improve control performance when the process was subjected to disturbance changes (F and z_F). Compared to the PI controller, the first algorithm (MMPCPIMAX) provided better control performance when the disturbance sizes were moderate, but it was not able to handle a large disturbance of + 50% in z_F .

Keywords: Configuration; Control; Distillation; Multi-model; Predictive

1. INTRODUCTION

Chemical processes are processes that involve many unit operations with a variety of different characteristics. The processes are typically nonlinear, multivariable, and involving a high degree of process interactions, giving rise to a variety of operational complexities. These issues impact the performance of the plant operation system, the heart of which is process control. Since process controllers are generally developed based on linear systems, nonlinearity in process behavior causes substandard control performances. Furthermore, due to large number of process variables that are related in one way or another, interactions between control loops may not be fully avoidable, thus impacting the overall control performance. Since the process controllers typically used in the industry are based on linear Single-Input, Single-Output (SISO) design, the desirable plant performance cannot be established without human intervention, a

* Corresponding author's email: wahid@che.ui.ac.id, Tel. +62-21-7863516 Fax. +62-21-7863515
Permalink/DOI: <http://dx.doi.org/10.14716/ijtech.v6i3.1139>

requirement which in practice is alerted by the alarm systems. Although this approach is in principle workable and it has been in practice for many years, the need for better plant performance demands better control strategies.

In some specific plants such as petroleum refineries and various petrochemical plants, Model Predictive Control (MPC) has been introduced and is now receiving wide acceptance (Potts et al., 2014; Qin & Badgwell, 2003). MPC was an advanced process control method that has been in use in the process industries since the 1980's. The framework of MPC was introduced in the late 1970's and early 1980's by Richalet et al. (1978) and Cutler (1983). While the inspiration began the Kalman filter (Kalman, 1960) was introduced to deal with complex industrial processes (Morari & Lee, 1999). Over the years, the technology has matured enough to be successfully applied to complex industrial processes (Xi et al., 2013), and it was reasonable to say that MPC has become the *de facto* standard algorithm for advanced process control in the process industries (Hossain, 2013; Nikolaou, 1998). About 20 years after its introduction, more than 600 industrial applications were reported (Qin & Badgwell, 2003), and to date, the number is expected to be much larger (Kozák, 2014). The key of the popularity of MPC in industry and the academic world is because MPC offers a mutual relationship between simplicity and performance (Fatihah, 2013; Dubay, 2006). Along the way, many developments have been put forward to improve the efficiency of the controller and to address the difficulties faced in applications.

Although human intervention is possible, such dependence defeated the purpose and philosophy in using MPC in the first place, which aims at providing accurate automatic control to enable higher level efforts such as Real Time Optimization (RTO), or production of high purity products. These initiatives often require the plant to operate the process under constraints, which is a very interactive procedure from a multivariable control strategy, where an accurate nonlinear model of the process is used within a control framework such as Model Predictive Control (MPC). The direct use of nonlinear models for predictions using a Nonlinear MPC (NMPC), is advantageous as it provides accurate prediction of process behavior and explicit consideration of state and input constraints. As such, better control can be established, especially when the model is comprehensive and accurate.

Despite these clear advantages, the application of NMPC in the process industry is still limited. One of the key reasons is the fact that the model is more difficult to be fitted and it is more difficult to be understood by plant operators compared to its linear counterparts. It also requires highly intensive calculation to produce the control moves by solving a large scale, nonlinear program on-line during each sampling period (Ellis & Christofides, 2015; Magni et al., 2009). As a consequence, it is less popular in the industry.

A promising solution to overcome this issue is to employ a Multi-model MPC or Multiple MPC (MMPC). In this case, the models are basically consisting of an array of linear models in Multiple-Input, Multiple-Outputs (MIMO) configuration at each certain range of Control Variables (CVs) or Output Variables (OV). The advantages of this strategy are its simplicity in modeling, better predictability, and ease of maintenance. However, since it is essentially a Linear MPC (LMPC), it is still subject to all the limitations of the typical LMPC.

The MPC or the MMPC has a problem when dealing with disturbance rejection. One strategy to address this weakness is by taking advantage of both approaches in a hybrid controller configuration, pursuing along the same lines the work of Singh et al. (2013), where a combined Proportional Integral Derivative (PID) – MPC approach with a mechanism to select separate strategies for the outputs, such as the Controlled Variables, (CV) was proposed. In their work, CVs that are expected to suffer from higher interactions and large time delays were managed by a hybrid MPC-PID in a cascade configuration, while the other variables were controlled using

PID alone. In an earlier paper, Huang and Riggs (2002a, b) reported their work in incorporating Proportional-Integral (PI) and MPC for controlling the level of a distillation column (C3 splitter) also by means of the cascade configuration.

In this paper, an approach in dealing with disturbance handlings is proposed. The strategy relates to the selection of output configurations of the MMPC and the PI controller to maximize or minimize both. The PI controller was used in this study because it is more widely used in industry than the PID controller (Rao & Misra, 2014).

2. CONTROLLER FORMULATION

Figure 1 shows the proposed selective output configuration strategy. In a nonlinear distillation column control, there are two kinds of input (u): reflux flow (L) and boilup flow (V), two outputs (y): distillate (y_D) and bottom (y_B) composition, two disturbances (d): feed flow rate (F) and feed composition (z_F), and set-point tracking (w). Both of these controller outputs are to be maximized or minimized in order to achieve the desired conditions. Consequently, four possible configurations can be considered: maximizing u , or minimizing u , or conditional (min-max and max-min). The best combination of these four configurations is later determined according to the empirical results of a series of tests in the distillation column.

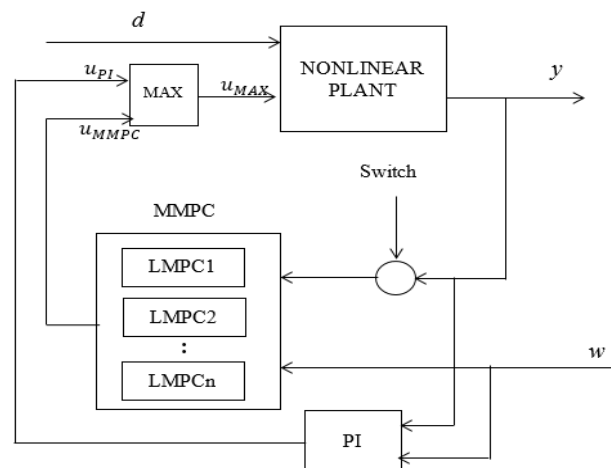

Figure 1 MMPCPIMAX controller algorithm

3. EXPERIMENTAL

Two tests were conducted in the nonlinear distillation model of Column A (Skogestad, 2007): firstly, the test is conducted to obtain the best configuration among those four possible configurations mentioned earlier, and secondly, further a test was performed over the best configuration against other controllers.

The first test was carried out on two conditions:

- i. Test with set-point tracking only. This test aimed at observing the tendency of the effect of those four possible configurations on the set-point tracking, whether the controller provides better performance than that of the PI controller as in the original configuration (MMPC without the controller output configuration). If the controller performances of those four possible configurations are better than that of the PI controller, consequently the next test could be carried out. However, if these four configurations showed worse performances, then the next test cannot be conducted as the original MMPC configuration is superior.

- ii. Test with the combination of set-point tracking and disturbance rejection. This test is aimed at investigating the effect of each configuration toward both changes, to determine which configuration will give the best control performance compared to the PI controller.

Under both conditions, the magnitude of a set-point tracking change was ranging from 0.01 to 0.03 and the disturbance rejection magnitude for the first test was only provided at +20%, either for disturbance of the feed flow rate (F) or the feed composition (z_F). For the second test against the best (chosen) configuration, the disturbance rejection magnitude was at +20% and +50%, respectively.

4. RESULTS AND DISCUSSION

4.1. Test for Determining the Best Configuration

Table 1 summarizes the results on the application of the four possible selective output configurations against the set-point change only.

Table 1 Controller performance of possible min-max configuration control (setpoint changes only)

No	Controllers	ISE $\times 10^4$					
		$t < 100$		$t \geq 100$		Total	
		y_D	y_B	y_D	y_B	y_D	y_B
1	MPCPIMAXMAX	0.79	1.61	4.04	2.55	4.83	4.16
2	MPCPIMINMAX	0.54	10.9	30.8	5.43	31.4	16.4
3	MPCPIMAXMIN	1.26	2.95	3.02	21.6	4.28	24.5
4	MPCPIMINMIN	0.21	1.10	8.73	12.7	8.94	13.8
5	PI	1.01	1.88	3.95	2.47	4.96	4.35

As indicated by that table, before $t = 100$ min., the configuration of min-min provided the best control performance, the y_D or y_B . The min-max configuration was the worst, mainly because this configuration gave greater oscillation in both controller inputs. Filtering minimum reflux boilup flow and maximum flow interactions resulted in both nonlinear distillation columns that were not mutually improved. It also occurred at $t \geq 100$ min., thus the overall configuration was the worst. The mutually improved conditions occurred particularly if the controller output is either maximized or minimized.

The configuration of max-max and min-min were observed to be competitive in terms of performance. At $t < 100$ min., the min-min configuration is best, while at $t \geq 100$ min., max-max configuration was superior. However, in the overall sense, the configuration of max-max was most superior.

In tests involving two changes (set-point tracking and disturbance rejection), a disturbance change was after $t = 100$ min followed by the set-point change. In the feed flow (F) disturbance change, the performance of the min-max configuration was the worst, with a high negative overshoot recorded. On the other hand, the max-min configuration produced the worst result at output y_B . Table 2 reveals that for the overall tests, the best performance was established by the max-max configuration, despite the fact that the max-min configuration delivered the best result at output y_D when compared to the others.

Table 2 Controller performance of possible min-max configuration control
(with disturbance change at $t = 100$ min.)

No	Controllers	ISE $\times 10^4$											
		$\Delta F = +20\%$						$\Delta z_F = +20\%$					
		t < 100		t \geq 100		Total		t < 100		t \geq 100		Total	
		y_D	y_B	y_D	y_B	y_D	y_B	y_D	y_B	y_D	y_B	y_D	y_B
1	MPCPIMAXMAX	0.79	1.61	0.61	1.01	1.40	2.63	0.79	1.61	0.29	1.22	1.08	2.83
2	MPCPIMINMAX	0.54	10.9	1.22	1.96	1.76	12.9	0.54	10.9	1.18	2.35	1.72	13.3
3	MPCPIMAXMIN	1.26	2.95	0.29	1.04	1.56	3.99	1.26	2.95	2.36	5.71	3.63	8.66
4	MPCPIMINMIN	0.21	1.10	1.27	1.36	1.48	2.46	0.21	1.10	2.36	9.89	2.56	11.0
5	PI	1.01	1.88	1.16	1.086	2.17	2.97	1.01	1.88	0.85	1.17	1.86	3.06

The behavior of inputs and outputs after the change of disturbance z_F were more diverse than those with the change of disturbance F . In dealing with the feed flow change (ΔF), the actions of PI controller were more aggressive compared to that of the MMPC. The relationship is therefore:

$$u_{PI} > u_{MMPC} \quad (1)$$

While the opposite result occurred on the disturbance caused by the feed composition changes (Δz_F), where the condition of controller output is as follows:

$$u_{PI} < u_{MMPC} \quad (2)$$

The max-min configuration produced the worst control performance at output y_D , while the min-min configuration was worst at output y_B , as shown in Table 2. This result is in fact contradictory with Equation 3 which states that the optimum output controller characteristics in the change of disturbance z_F should minimize the controller outputs.

Generally, based on these three test conditions i.e. only set-point change, disturbance change of F and z_F at $t = 100$ min., the max-max configuration was found to be the best controller. Therefore, the max-max mode, or simplified as max later on, was chosen for the following tests. The selected configuration equation is shown as:

$$u_{MMPCPIMAX} = \text{MAX}(u_{MMPC}, u_{PI}) \quad (3)$$

Hence, Figure 1 only shows the max (max-max) configuration. The selection of the max mode, according to the optimal controller output changes (Δu) concept, was related to the condition, while the tuning parameter for the desired closed-loop performance (r_ω) was zero (Wang, 2009).

In order to test the robustness of this configuration, a test on similar set-point tracking was conducted, but instead it was for a disturbance rejection of 50%, as carried out in the previous chapters. The results and discussion of this test will be explained in the next section.

4.2. Disturbance Change: Feed Flow (F) on MMPCPIMAX

Figures 2–4 show the performance comparison of several MMPCPIMAX controllers against set-point changes and disturbances. In addition, the effect of this configuration towards control performance is elaborated in comparison with the performance of a single MPC (SMPC) and a single MPC-PI using MAX configuration (SMPCPIMAX).

Figure 2 shows that the performance of SMPC (using MPC.02) can be improved using this configuration (SMPCPIMAX). A significant improvement was achieved in response, although it was not as good as the response of PI controller towards the same disturbance.

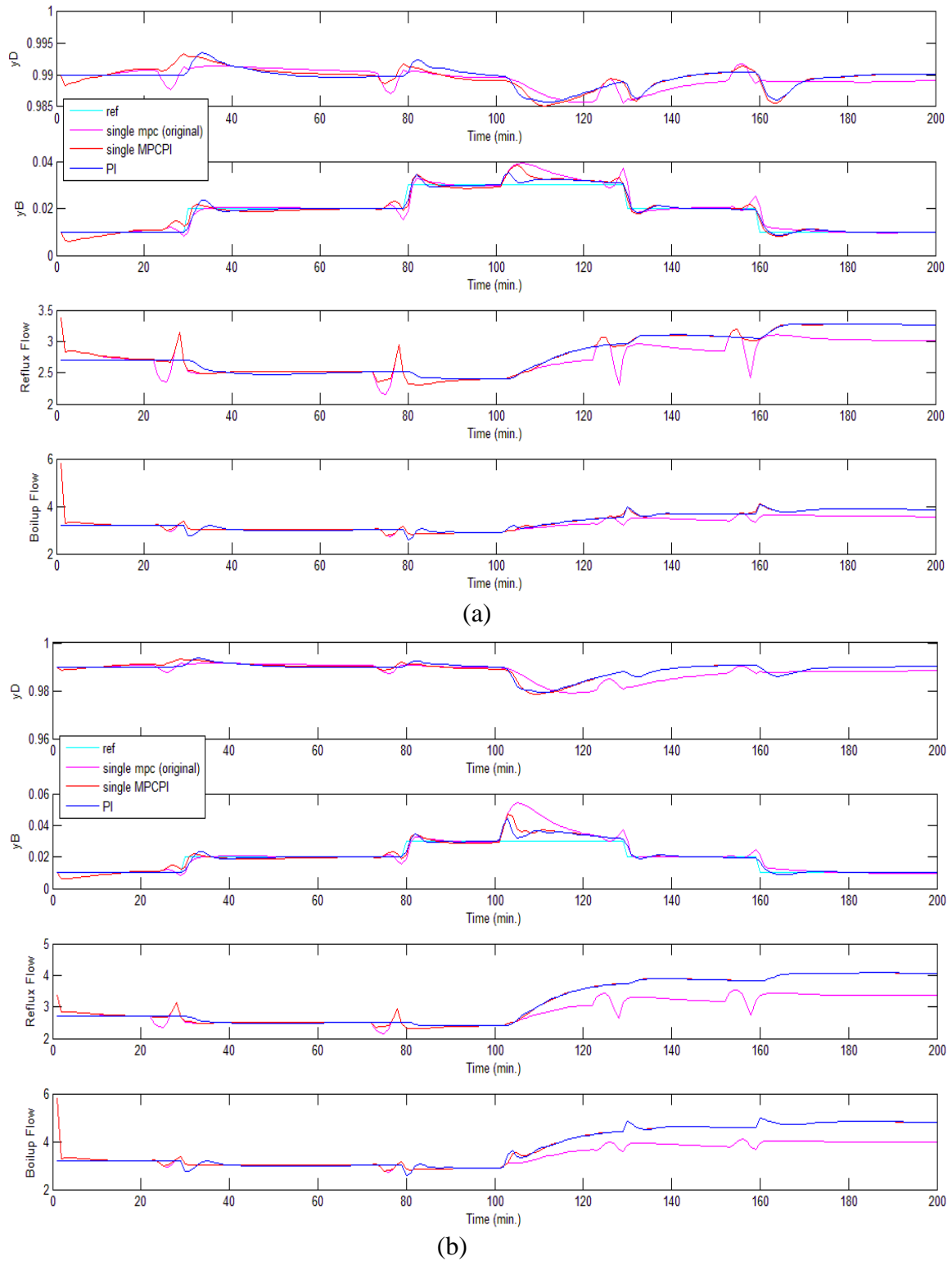

Figure 2 Controller performance of SMPC, SMPCPIMAX, and PI: a) $\Delta F = +20\%$; b) $\Delta F = +50\%$

As shown in Table 3, for ΔF disturbance of +0.1 kg-mole/min. (+20%), the improvement (in ISE) was 44% for y_B (bottom composition), although for y_D (distillate composition) the SMPC was slightly better. For ΔF disturbance of +0.25 kg-mole/min, a larger value was obtained i.e. 79% for y_B , and 39% for y_D .

Table 3 Controller performances based on MAX(u) with disturbance change of F

No	Controllers	ISE $\times 10^4$			
		$\Delta F = +20\%$		$\Delta F = +50\%$	
		y_D	y_B	y_D	y_B
1	SMPC	5.49	15.00	28.00	56.00
2	SMPCPIMAX	5.82	8.34	18.00	12.00
3	MMPCPIMAX	4.84	4.16	18.00	11.00
4	PI	4.96	4.35	18.00	11.00

From Figure 2, at $t < 25$ min, both input and output variables of SMPC and SMPCPIMAX exhibited certain behaviors; while at $t = 25-100$ min, the third controller (SMPC, SMPCPIMAX and PI) showed different trends, but after 100 minutes, the performance of the SMPCPIMAX results were compatible to that of the PI controller. This means that the controller output used by SMPCPIMAX sometimes used the output of the PI controller, while at other times different output was used for the next set-point change.

As shown in Figure 3, the use of MMPCPIMAX improved the performance of MMPC. Overall, MMPCPIMAX also produced better performance compared to the PI controller, although the performance dealing with ΔF disturbance of +0.25 kg-mole/min was similar because controller output used by MMPCPIMAX was the output of the PI controller.

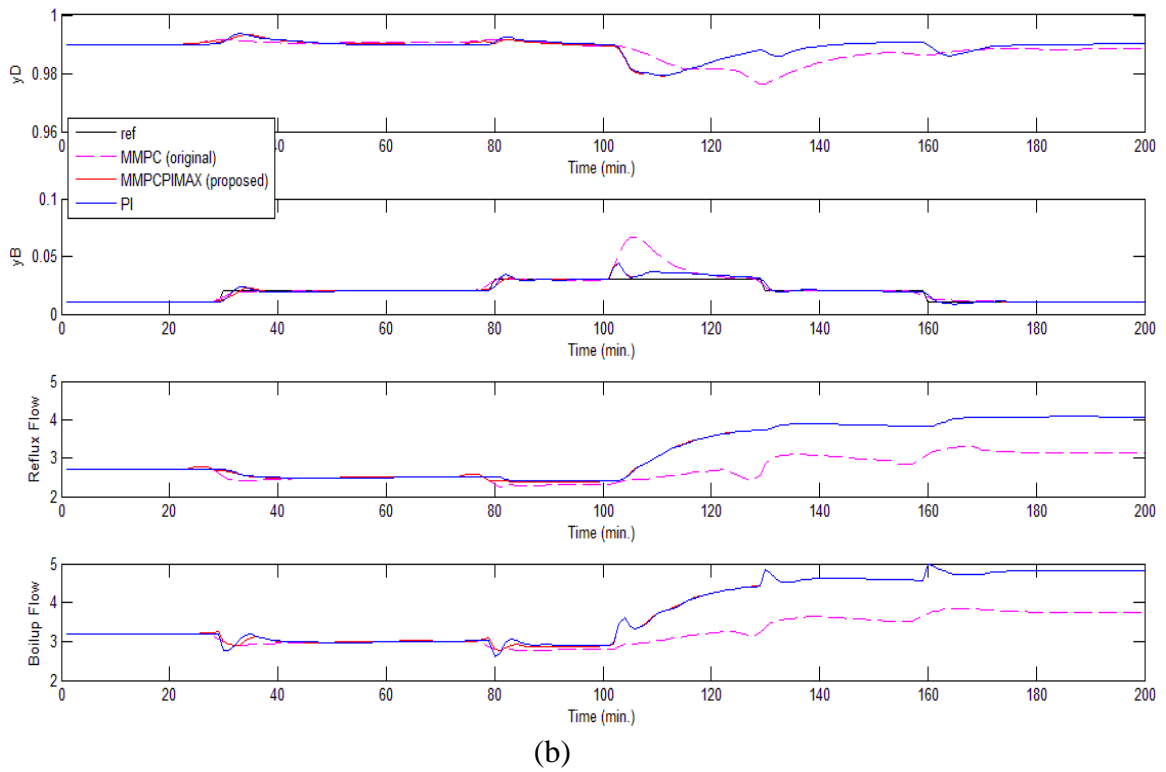
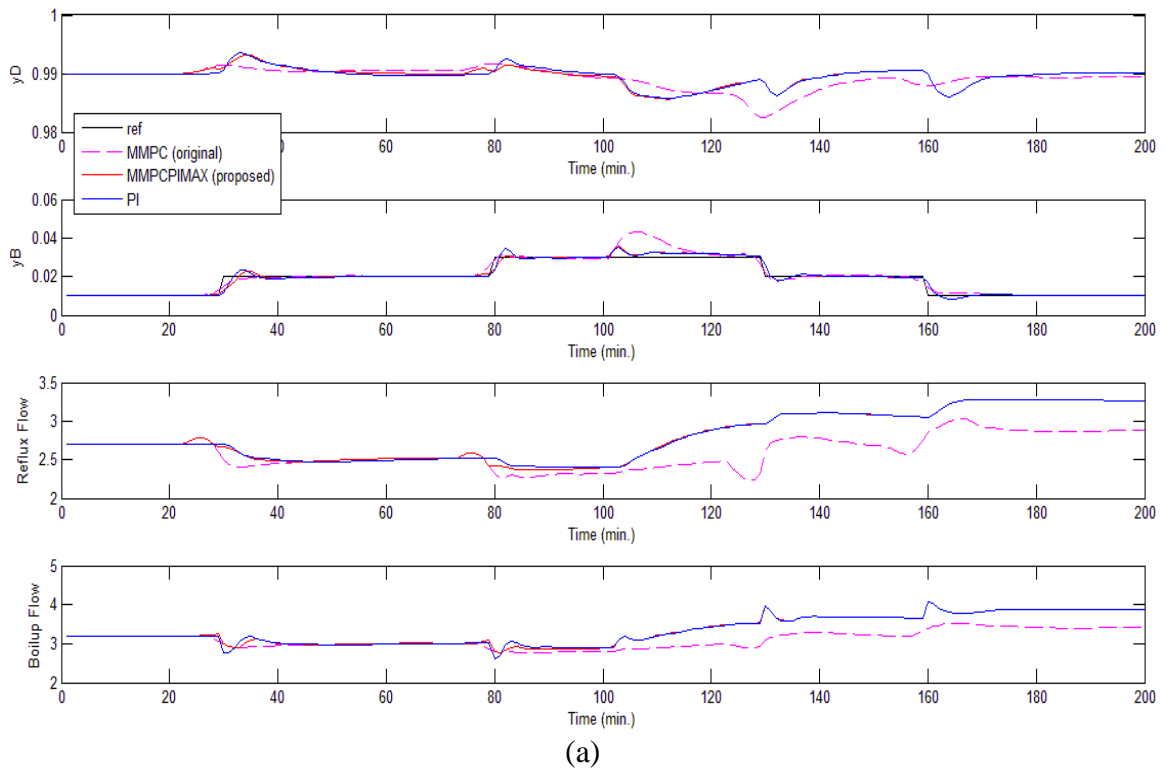

Figure 3 Controller performance of MMPCPIMAX and PI: a) $\Delta F = +20\%$; b) $\Delta F = +50\%$

LMPC was used on MMPCPIMAX as shown in Figure 4 in accordance with the magnitude ΔF , on the $\Delta F = +50\%$, four LMPCs were used.

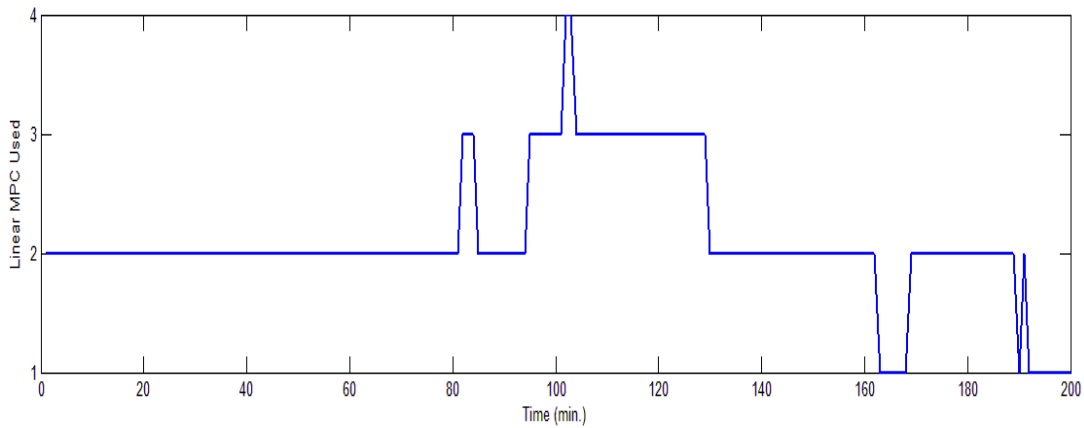

Figure 4 Switching of MMPCPIMAX ($\Delta F = +50\%$)

The improvement in performance provided by the MMPCPIMAX was in the way it responded to disturbances and the chosen controller outputs were based on the PI controller. Note that the aim of this algorithm was to establish the optimum control law, and it was achieved with the MMPCPIMAX. This is for the response against disturbance of feed flow (F).

4.3. Disturbance Change: Feed Composition (z_F) on MMPCPIMAX

The results as in Table 1 indicate that the max-max configuration was also suitable for z_F disturbance. As in the outcome of MMPCPIMAX against F disturbance, a similar result was produced for the z_F disturbance (Table 3). MMPCPIMAX also improved the performance of SMPC and SMPCPIMAX. Even in the presence of such disturbance, while the highest setpoint of y_B is 0.03, the linear/single MPC used remained three, i.e. SMPC.01, SMPC.02 and SMPC.03, respectively.

The behavior of MMPCPIMAX against z_F disturbance differed from that against the F disturbance. While the F disturbance controller outputs of MMPCPIMAX were the same as that of the PI, this scenario did not apply for the z_F disturbance.

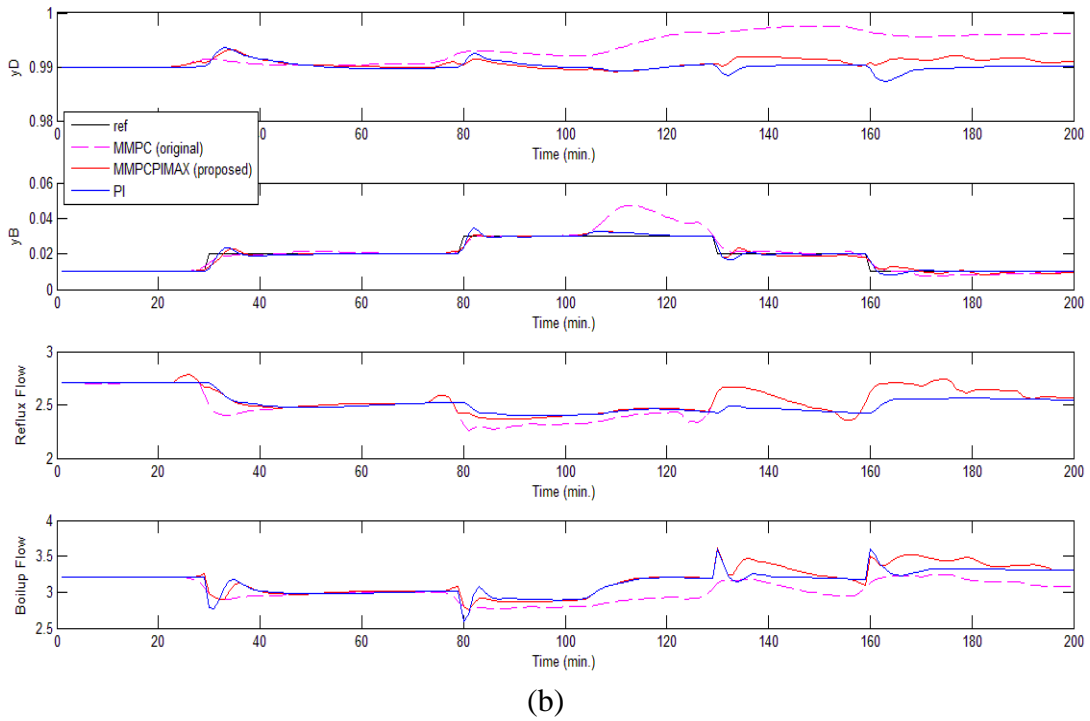
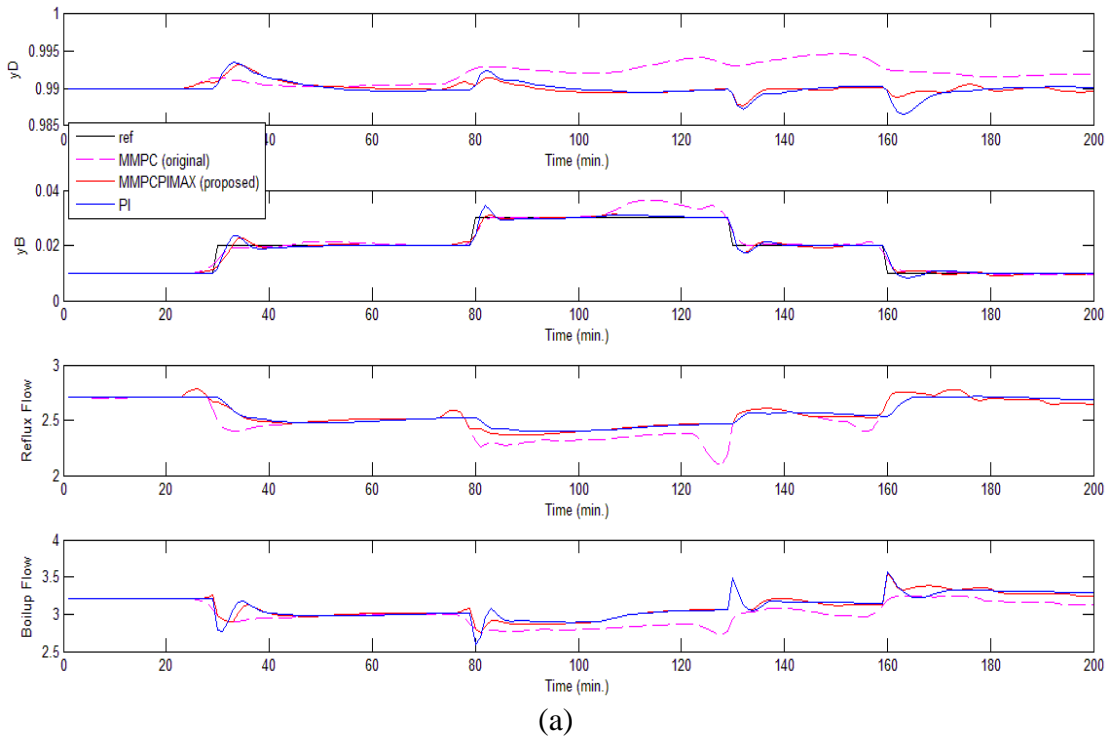
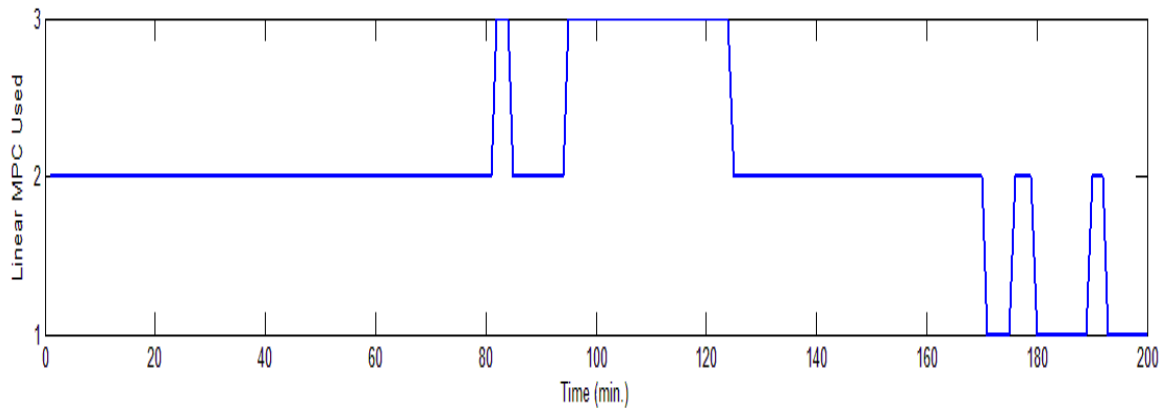

Figure 5 Controller performance of MMPCPIMAX and PI: a) $\Delta z_F = +20\%$; b) $\Delta z_F = +50\%$

Although, this controller was better than the PI controller in terms of a z_F change of +20% as shown in Figure 5(a); as revealed in Figure 5(b), when a disturbance of +50% in z_F (0.75 of 0.5) was introduced, the chosen controller outputs were not that of the PI but were based on others with more oscillatory behavior. Therefore, the performance of MMPCPIMAX was worse than that of PI (see Table 4). LMPC was used on MMPCPIMAX as shown by Figure 6 in accordance with the magnitude Δz_F , on the $\Delta F = +50\%$ three LMPCs were used.

Figure 6 Switching of MMPCPIMAX ($\Delta z_F = 50\%$)

However, MMPCPIMAX have shown that the configuration of its controller outputs already improved the performance of MMPC even with the disturbance change as high as +20% it produced better performance against other controllers.

Table 4 Comparison of controller performances with disturbance change (z_F)

No	Controllers	ISE $\times 10^4$			
		$\Delta z_F = +20\%$		$\Delta z_F = +50\%$	
		y_D	y_B	y_D	y_B
1	SMPC	2.74	11.00	9.81	25.00
2	SMPCPIMAX	2.45	8.58	3.88	13.00
3	MMPCPIMAX	1.08	2.83	2.23	3.83
4	PI	1.86	3.06	1.48	3.46

5. CONCLUSION

The controller output configurations of PI and single linear MPC (SMPC) have been proven to be able to improve control performance when the process was subjected to disturbance changes (F and z_F). This configuration (SMPCPIMAX) was able to improve the controller performance significantly when applied to the SMPC. Similarly, when applied to the MMPC structure, both configurations were also capable of improving the controller performance. Compared to the PI controller, the MMPCPIMAX algorithm provided better control performance when the disturbance sizes were moderate, but it was not able to handle the large disturbance of + 50% in z_F .

6. REFERENCES

- Cutler, C.R., 1983. Dynamic Matrix Control – An Optimal Multivariable Control Algorithm with Constraints. *Ph.D. Thesis*, University of Houston
- Dubay, M. Abu-Ayyad, R., 2006. MIMO Extended Predictive Control—Implementation and Robust Stability Analysis. *ISA Transactions*, Volume 45(4), pp. 545–561
- Ellis, M., Christofides, Panagiotis, D., 2015. Real-time Economic Model Predictive Control of Nonlinear Process Systems. *AIChE Journal*, Volume 61(2), pp. 555–571

- Fatihah, M.A., Farah, 2013. A Simulation Study on Model Predictive Control Application for Depropanizer using Aspen Hysys. *Bachelor Thesis*, Universiti Malaysia Pahang
- Huang, H., Riggs, J.B., 2002a. Comparison of PI and MPC for Control of a Gas Recovery Unit. *Journal of Process Control*, Volume 12, pp. 163–173
- Huang, H., Riggs, J.B., 2002b. Including Levels in MPC to Improve Distillation Control. *Ind. Eng. Chem. Res.*, Volume 41, pp. 4048–4053
- Hussain, M.A., 2013. A Dual-rate Model Predictive Controller for Fieldbus Based Distributed Control Systems. *Master Thesis*, The University of Western Ontario
- Kalman, R.E., 1960. A New Approach to Linear Filtering and Prediction Problems. *Transactions of ASME, Journal of Basic Engineering*. Volume 87, pp. 35–45
- Kozák, Š., 2014. State-of-the-art in Control Engineering. *Journal of Electrical Systems and Information Technology*, Volume 1, pp. 1–9
- Magni, L., Raimondo, D.M., Allgöwer, F., (Eds.), 2009. *Nonlinear Model Predictive Control: Towards New Challenging Applications*. Springer-Verlag Berlin Heidelberg
- Morari, M., Lee, J.H., 1999. Model Predictive Control: Past, Current and Future. *Computers and Chemical Engineering*. Volume 23, pp. 667–682
- Nikolaou, M., 1998. *Model Predictive Controllers: A Critical Synthesis of Theory and Industrial Needs*. Chemical Engineering Dept. University of Houston
- Potts, A.S., Romano, R.A., Garcia, C., 2014. Improving Performance and Stability of MPC Relevant Identification Methods. *Control Engineering Practice*, Volume 22, pp. 20–33
- Qin, S.J., Badgwell, T.A., 2003. A Survey of Industrial Model Predictive Control Technology. *Control Engineering Practice*, Volume 11, pp. 733–764
- Rao, K.S., Misra, R., 2014. Comparative Study of P, PI and PID Controller for Speed Control of VSI-fed Induction Motor. *International Journal of Engineering Development and Research*. Volume 2(2), pp. 2740–2744
- Richalet, J., Rault, A., Testud, J.L., Papon, J., 1978. Model Predictive Heuristic Control: Applications to Industrial Processes. *Automatica*, Volume 14(5), pp. 413–428
- Skogestad, S., 2007. The Do's and Don'ts of Distillation Column Control. *Trans IChemE, Part A, Chemical Engineering Research and Design*, Volume 85(A1), pp. 13–23
- Singh, R., Marianthi, I., Rohit R., 2013. System-wide Hybrid MPC–PID Control of a Continuous Pharmaceutical Tablet Manufacturing Process via Direct Compaction. *European Journal of Pharmaceutics and Biopharmaceutics*, Volume 85, pp. 1164–1182
- Wang, L., 2009. *Model Predictive Control System Design and Implementation using MATLAB®*. Springer-Verlag London Limited
- Xi, Y-G., Li, D-W., Lin, S., 2013. Model Predictive Control – Status and Challenges. *Acta Automatica Sinica*, Volume 39(3), pp. 222–236