

Digital Communication

Base band Transmission and Receiver

Lecture-3

Ir. Muhamad Asvial, MSc., PhD

Center for Information and Communication Engineering Research (CICER)

Electrical Engineering Department - University of Indonesia

E-mail: asvial@ee.ui.ac.id

<http://www.ee.ui.ac.id/cicer>



Slide 1



Formatting and transmission of baseband signal

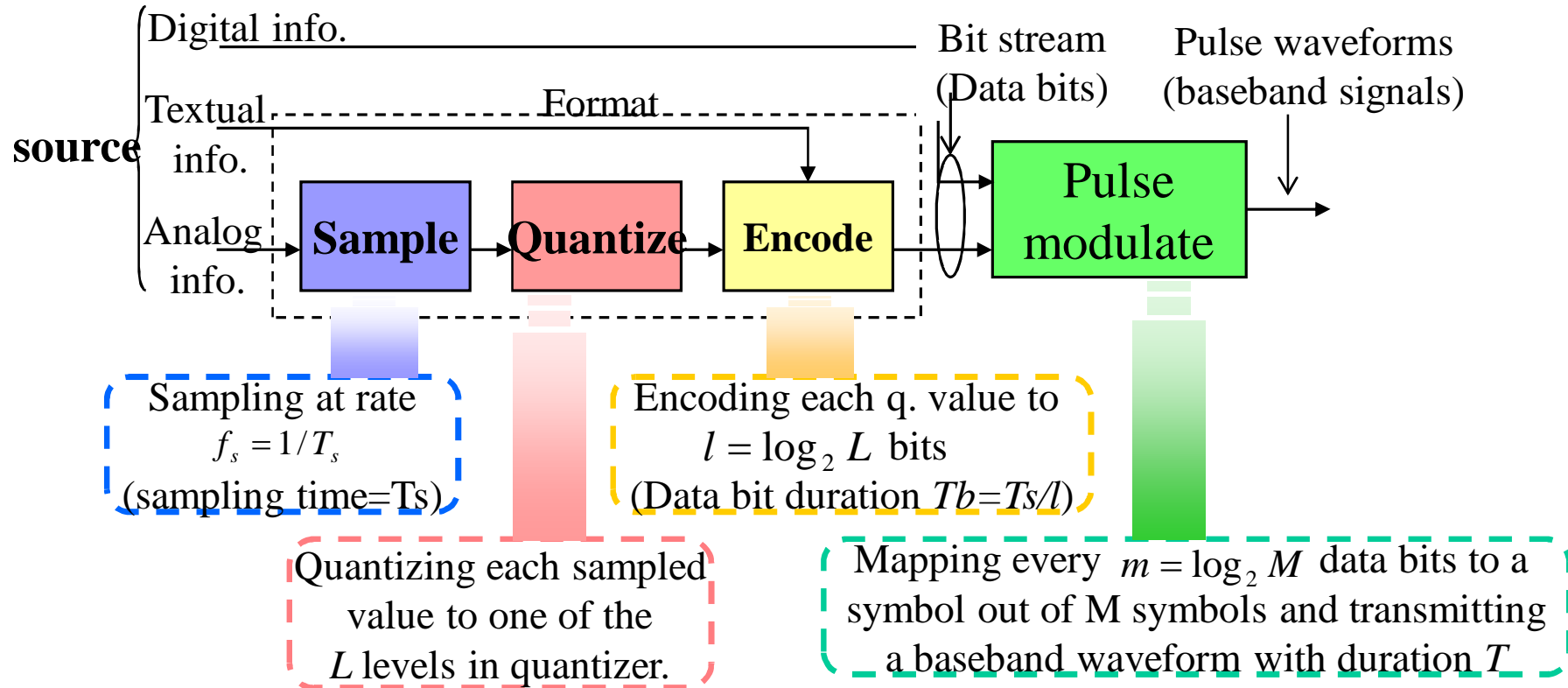

- Information (data) rate: $R_b = 1/T_b$ [bits/sec]
- Symbol rate : $R = 1/T$ [symbols/sec]

Quantization example

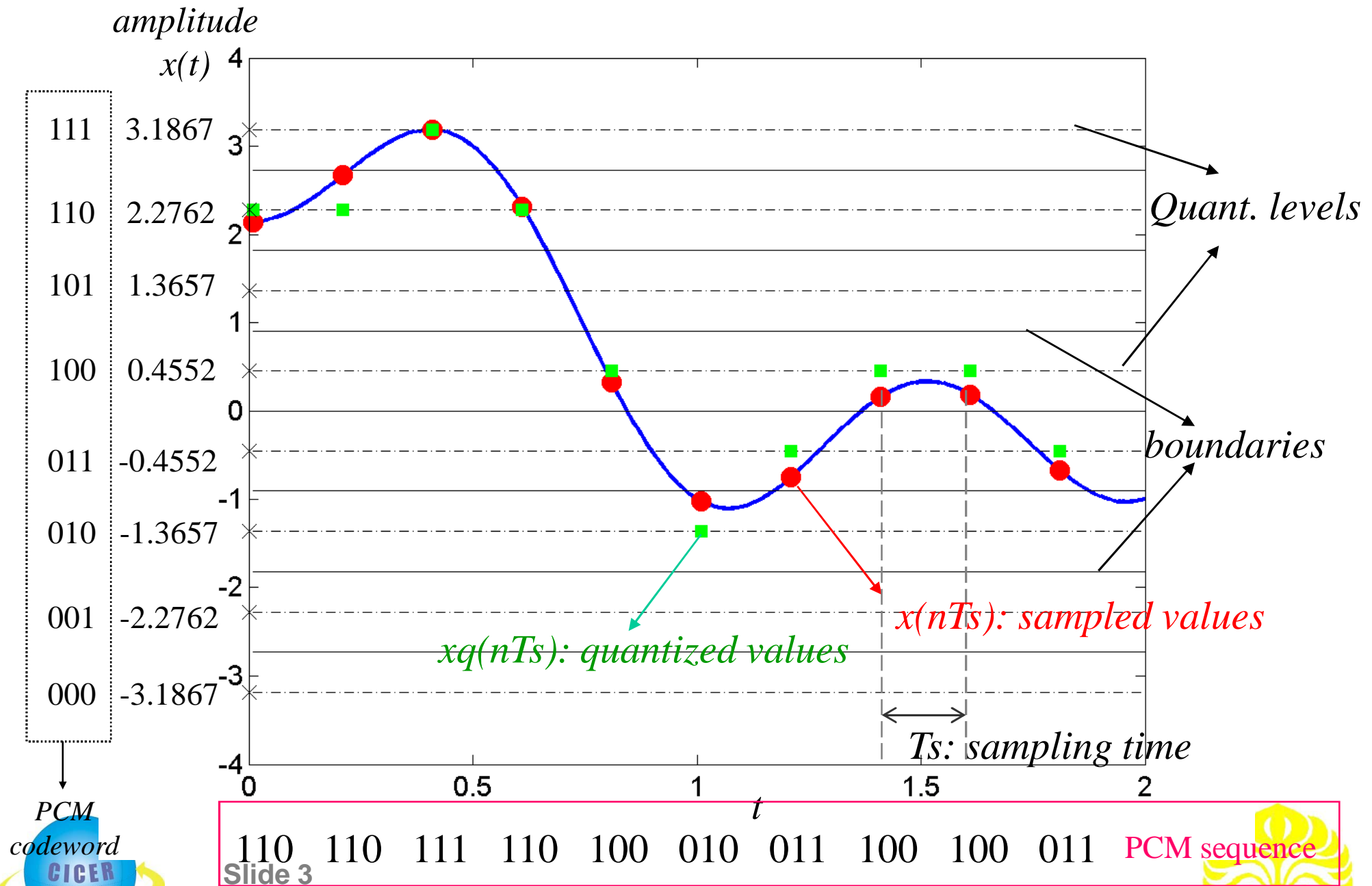

Demodulation and detection

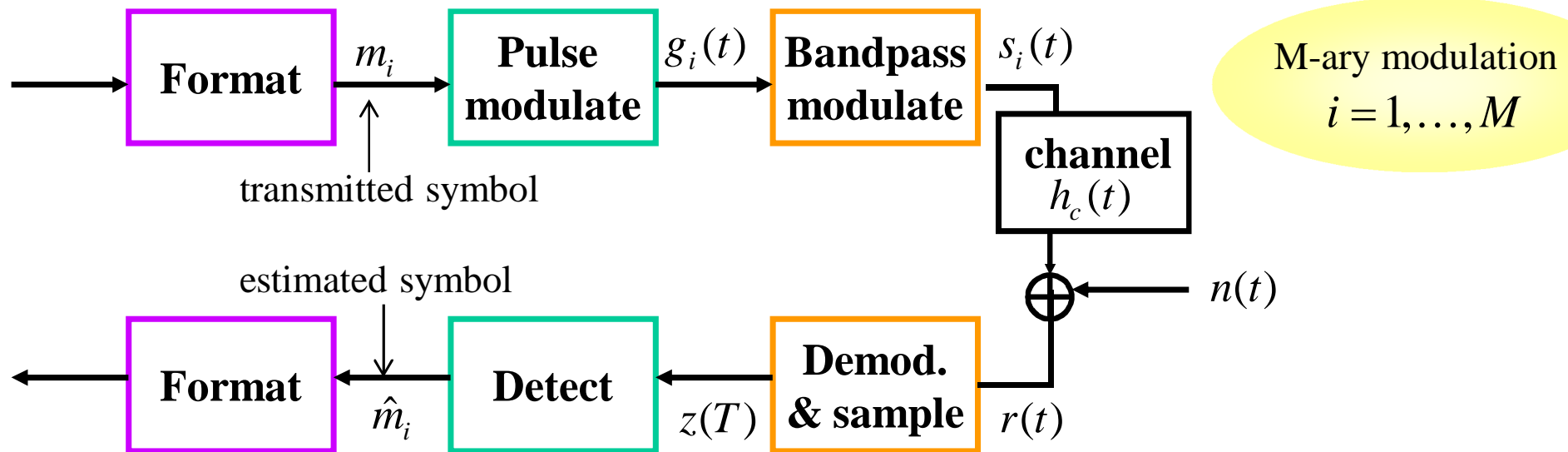

- Major sources of errors:
 - Thermal noise (AWGN)
 - disturbs the signal in an additive fashion (Additive)
 - has flat spectral density for all frequencies of interest (White)
 - is modeled by Gaussian random process (Gaussian Noise)
 - Inter-Symbol Interference (ISI)
 - Due to the filtering effect of transmitter, channel and receiver, symbols are “smeared”.



Example: Impact of the channel

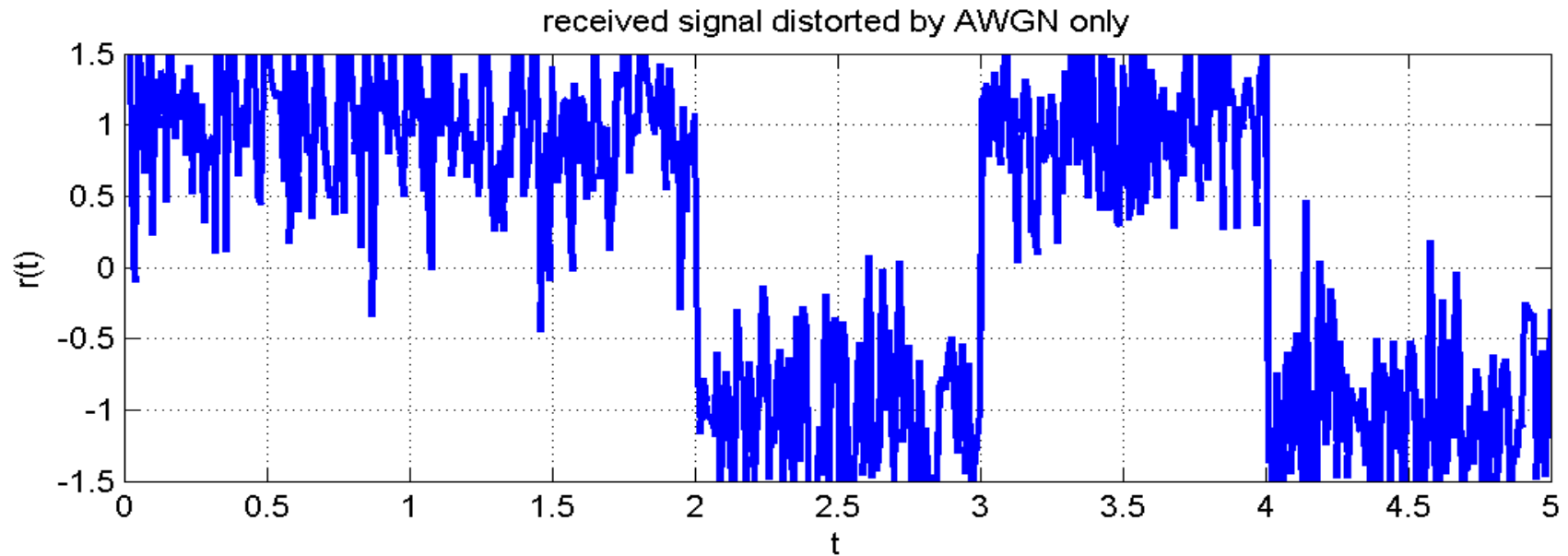
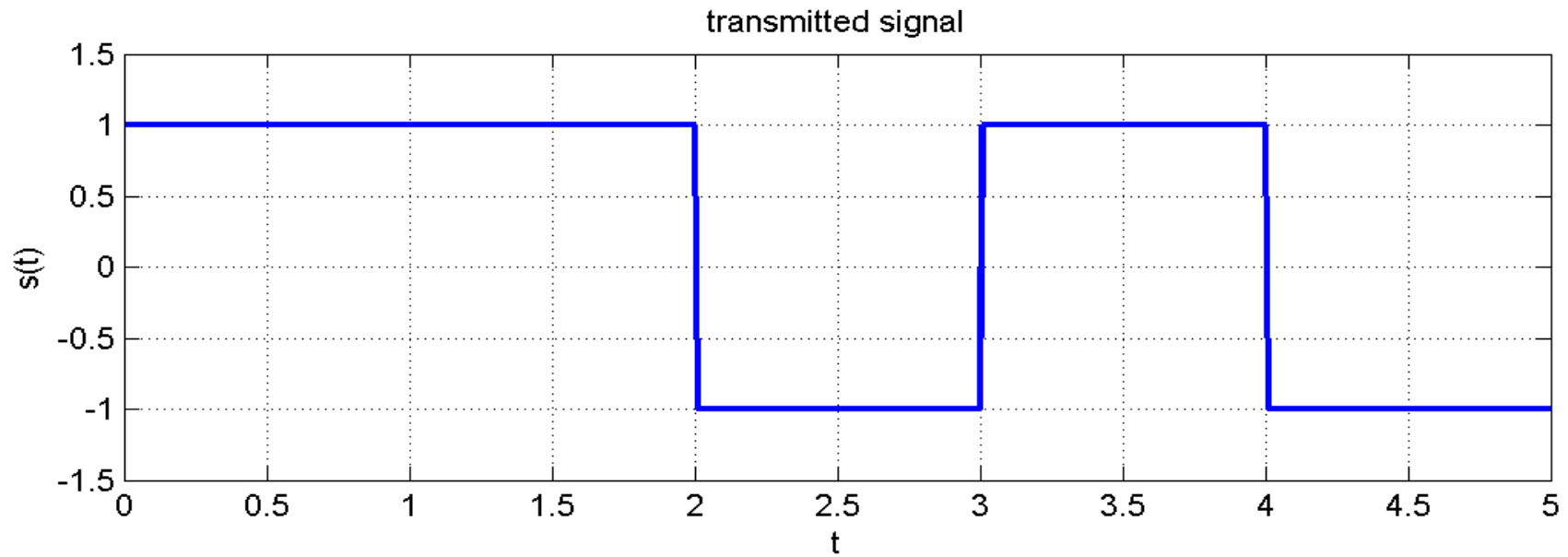

Example: Channel impact ...

received signal distorted by non-ideal channel only

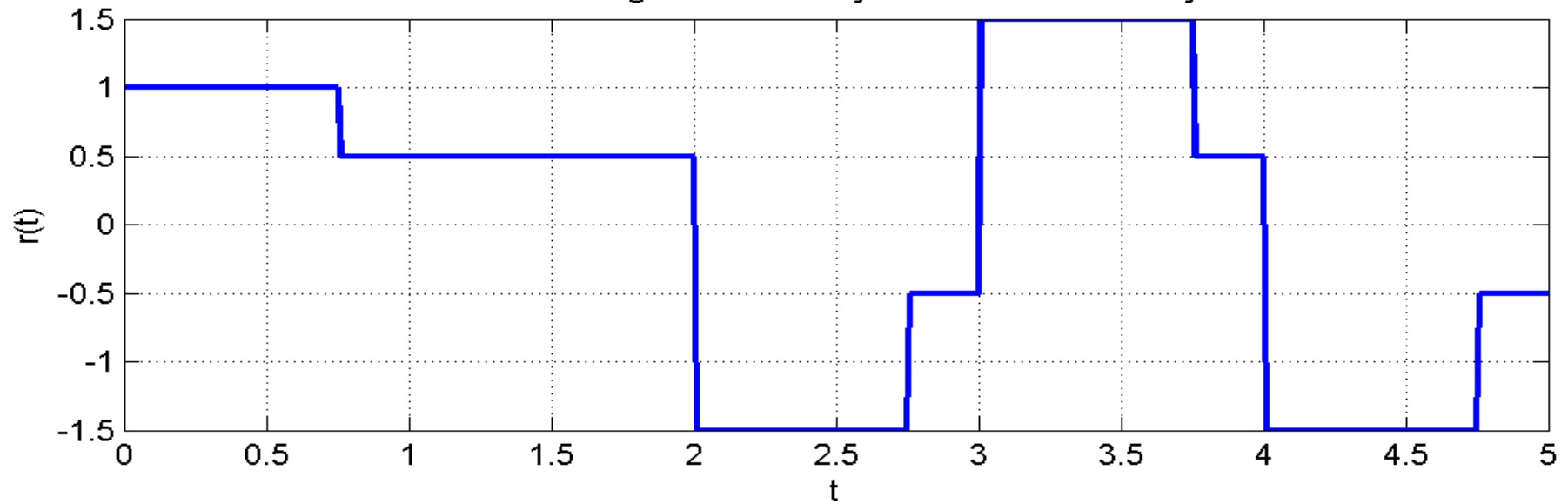

received signal distorted by channel and noise only

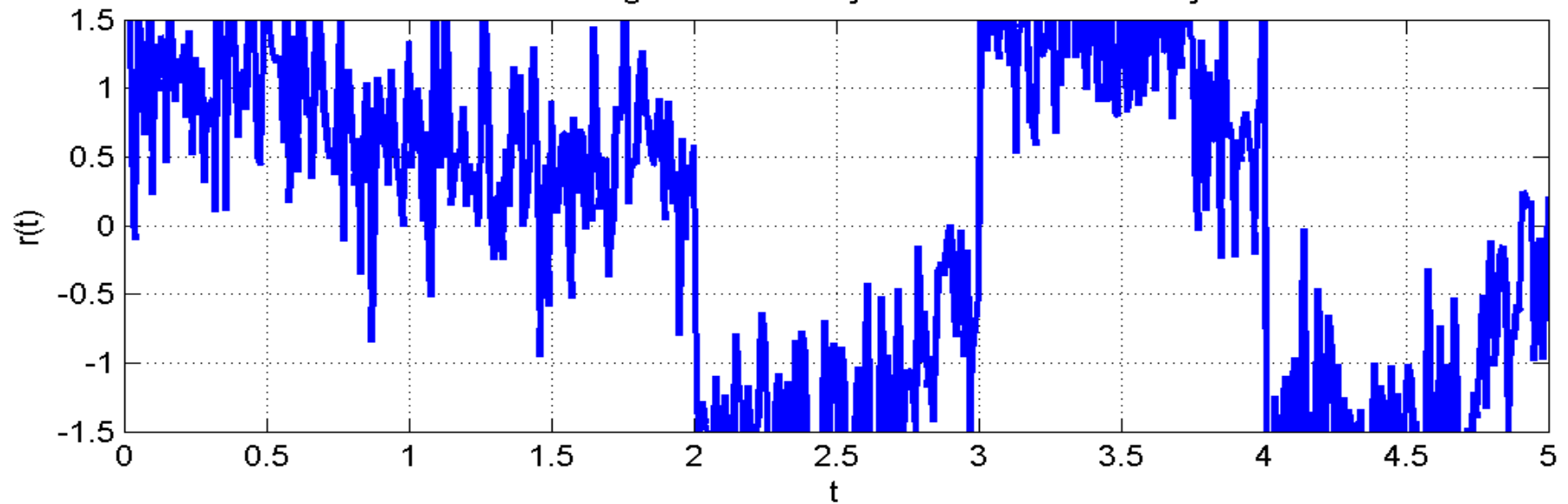

Receiver

- Demodulation and sampling:
 - Waveform recovery and preparing the received signal for detection:
 - Improving the signal power to the noise power (SNR) using matched filter
 - Reducing ISI using equalizer
 - Sampling the recovered waveform
- Detection:
 - Estimate the transmitted symbol based on the received sample



Receiver structure

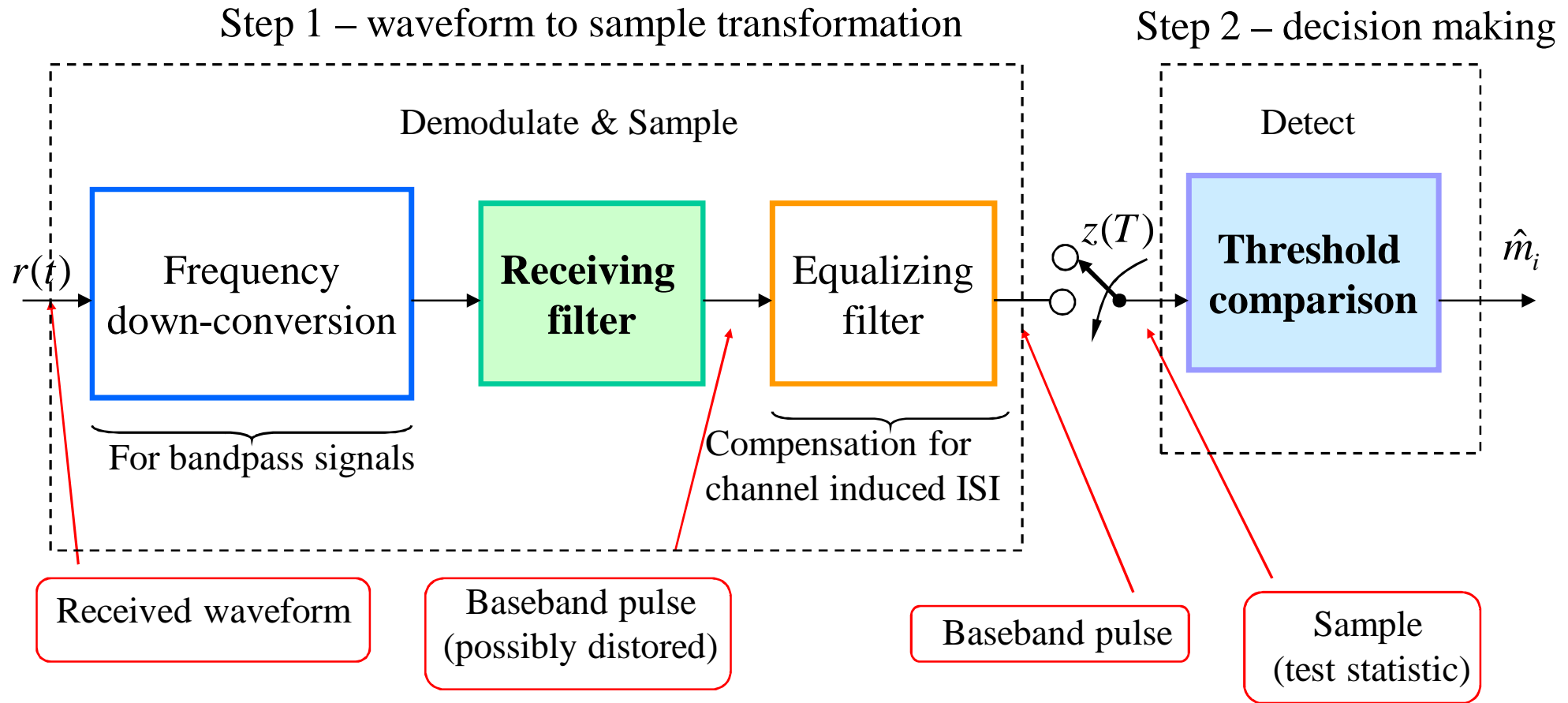

Baseband and bandpass

- Bandpass model of detection process is equivalent to baseband model because:
 - The received bandpass waveform is first transformed to a baseband waveform.
 - Equivalence theorem:
 - Performing bandpass linear signal processing followed by heterodying the signal to the baseband, yields the same results as heterodying the bandpass signal to the baseband , followed by a baseband linear signal processing.



Steps in designing the receiver

- Find optimum solution for receiver design with the following goals:
 1. Maximize SNR
 2. Minimize ISI
- Steps in design:
 - Model the received signal
 - Find separate solutions for each of the goals.
- First, we focus on designing a receiver which maximizes the SNR.



Design the receiver filter to maximize the SNR

- Model the received signal

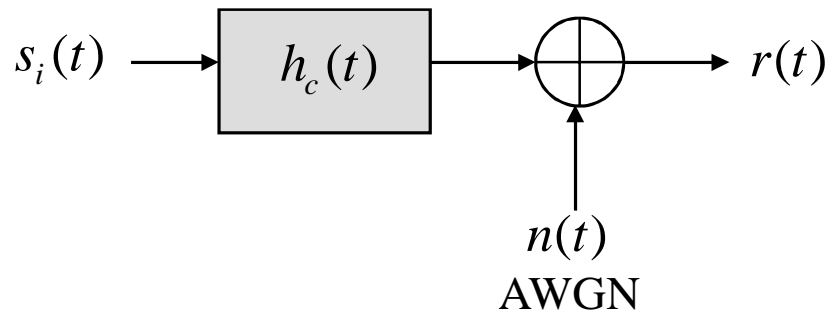

$$r(t) = s_i(t) * h_c(t) + n(t)$$

- Simplify the model:
 - Received signal in AWGN

Ideal channels
 $h_c(t) = \delta(t)$

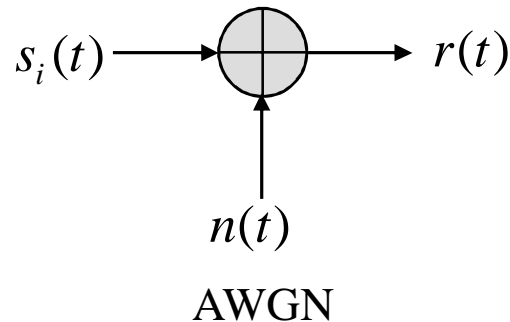

$$r(t) = s_i(t) + n(t)$$

Matched filter receiver

- Problem:
 - Design the receiver filter $h(t)$ such that the SNR is maximized at the sampling time when $s_i(t), i = 1, \dots, M$ is transmitted.
- Solution:
 - The optimum filter, is the Matched filter, given by

$$h(t) = h_{opt}(t) = s_i^*(T - t)$$

$$H(f) = H_{opt}(f) = S_i^*(f) \exp(-j2\pi fT)$$

which is the time-reversed and delayed version of the conjugate of the transmitted signal

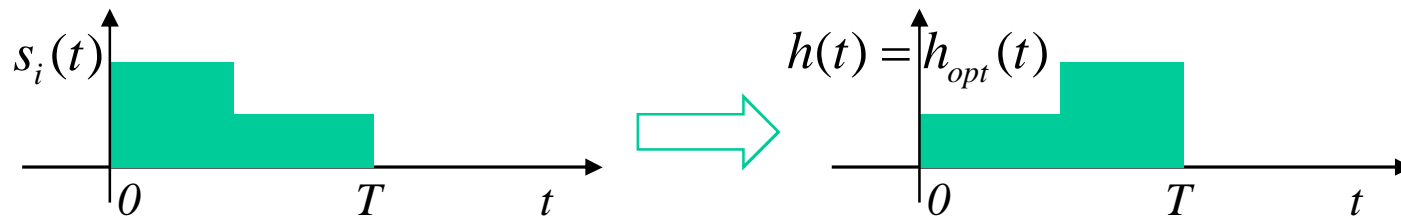

Example of matched filter

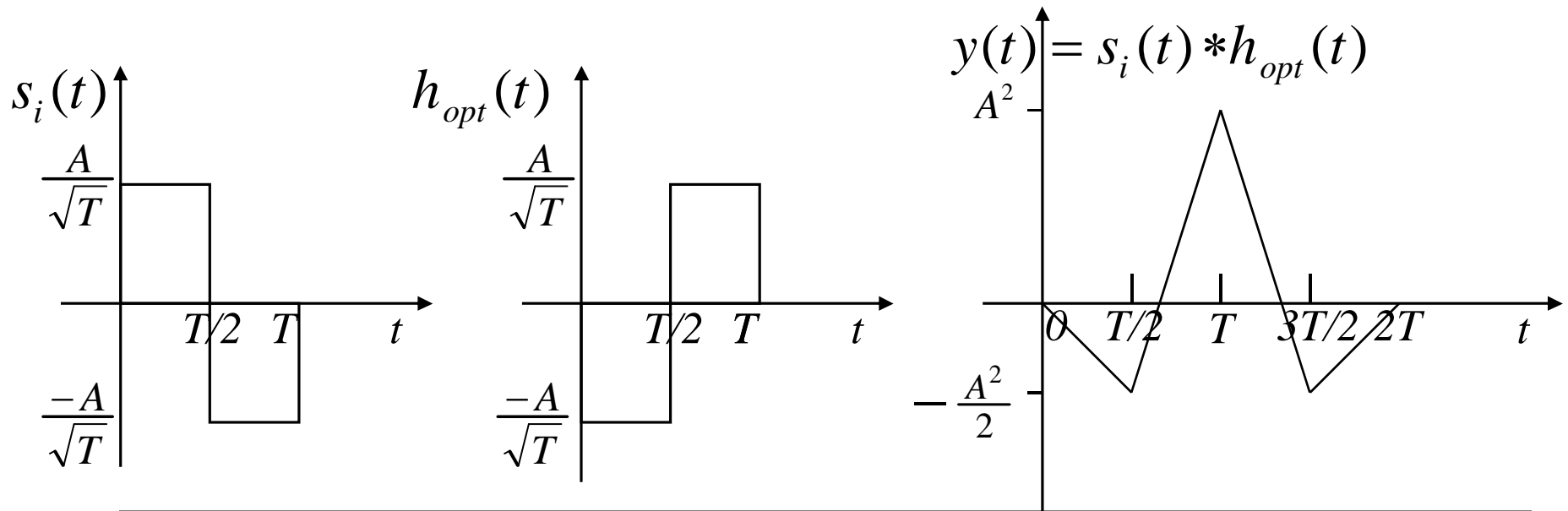
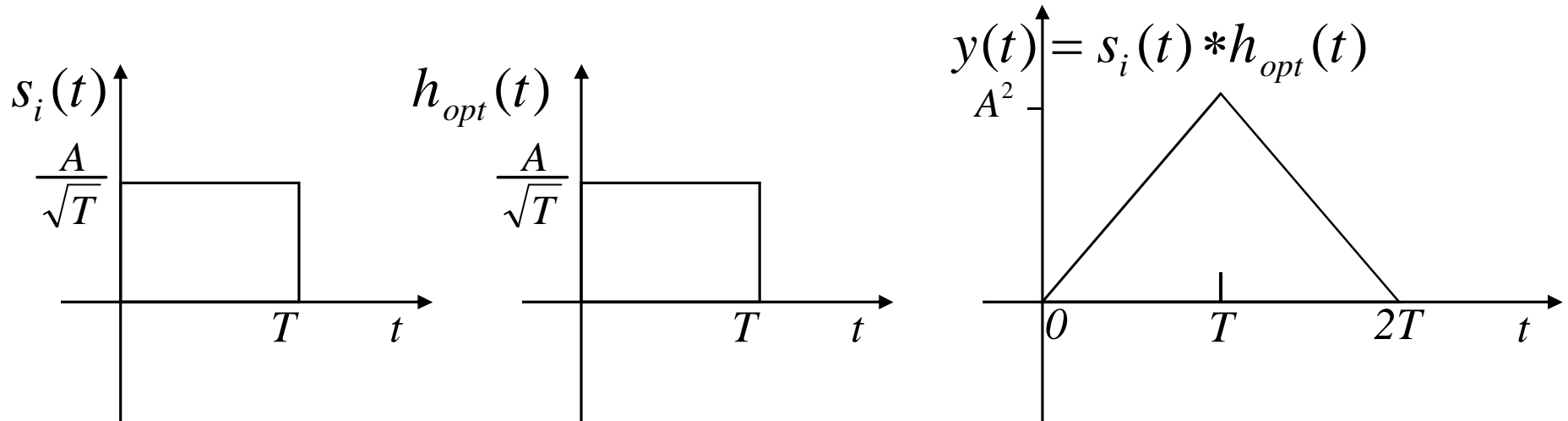

Properties of the matched filter

1. The Fourier transform of a matched filter output with the matched signal as input is, except for a time delay factor, proportional to the ESD of the input signal.

$$Z(f) = |S(f)|^2 \exp(-j2\pi fT)$$

2. The output signal of a matched filter is proportional to a shifted version of the autocorrelation function of the input signal to which the filter is matched.

$$z(t) = R_s(t - T) \Rightarrow z(T) = R_s(0) = E_s$$

3. The output SNR of a matched filter depends only on the ratio of the signal energy to the PSD of the white noise at the filter input.

$$\max \left(\frac{S}{N} \right)_T = \frac{E_s}{N_0 / 2}$$

4. Two matching conditions in the matched-filtering operation:

- spectral phase matching that gives the desired output peak at time T .
- spectral amplitude matching that gives optimum SNR to the peak value.

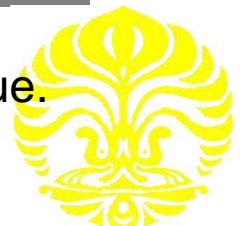

Correlator receiver

- The matched filter output at the sampling time, can be realized as the correlator output.

$$\begin{aligned} z(T) &= h_{opt}(T) * r(T) \\ &= \int_0^T r(\tau) s_i^*(\tau) d\tau = \langle r(t), s(t) \rangle \end{aligned}$$



Implementation of matched filter receiver

Bank of M matched filters

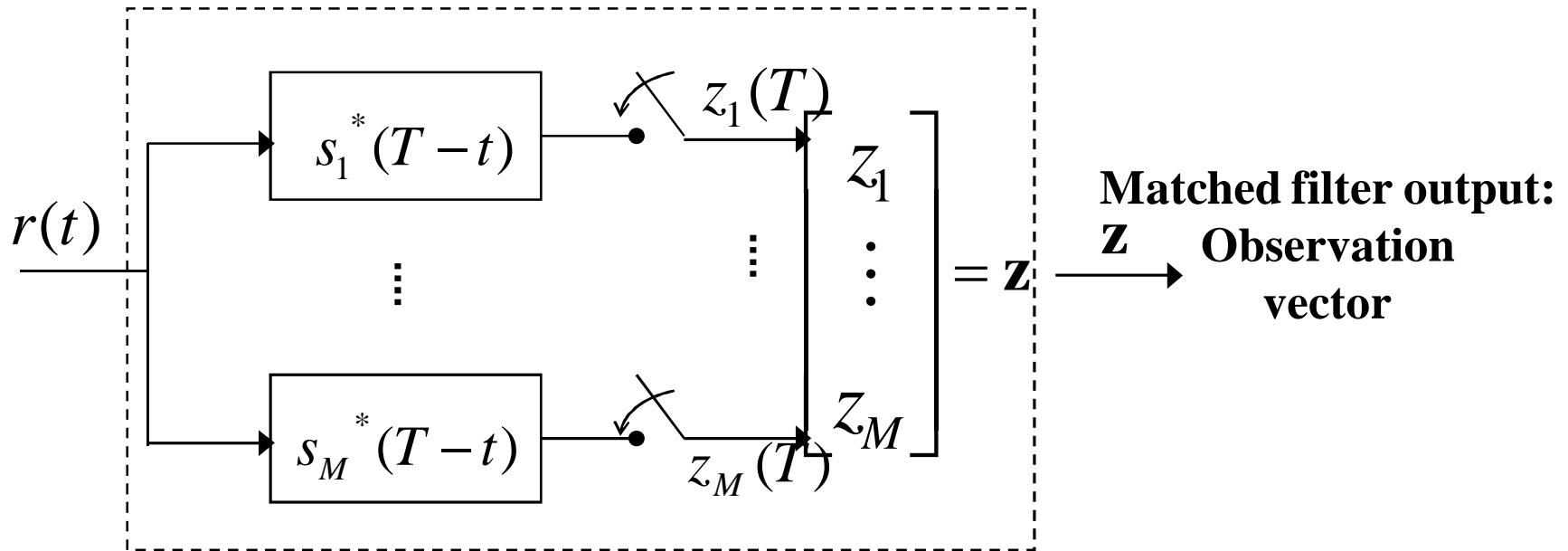

$$z_i = r(t) * s_i^*(T-t) \quad i = 1, \dots, M$$

$$\mathbf{z} = (z_1(T), z_2(T), \dots, z_M(T)) = (z_1, z_2, \dots, z_M)$$

Implementation of correlator receiver

Bank of M correlators

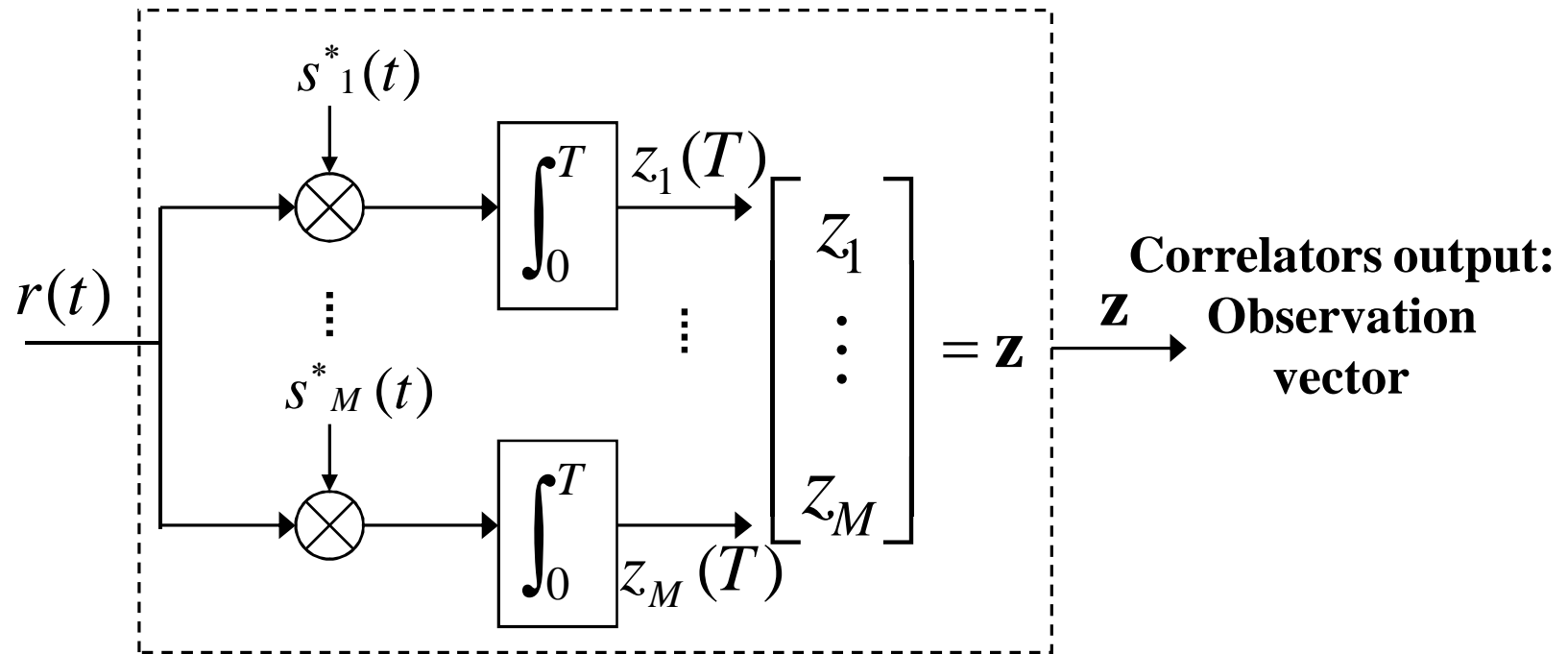

$$\mathbf{z} = (z_1(T), z_2(T), \dots, z_M(T)) = (z_1, z_2, \dots, z_M)$$

$$z_i = \int_0^T r(t) s_i^*(t) dt \quad i = 1, \dots, M$$

Implementation example of matched filter receivers

Bank of 2 matched filters

