

Cellular Network

Ir. Muhamad Asvial, MSc., PhD

Center for Information and Communication Engineering Research (CICER)

Electrical Engineering Department - University of Indonesia

E-mail: asvial@ee.ui.ac.id

<http://www.ee.ui.ac.id/cicer>



Slide 1

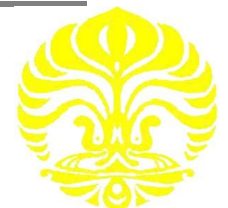

Cellular Concepts

- Mobile telephone service
- Distributed network of transmitters
- Use multiple low-power transmitters (100 W or less)

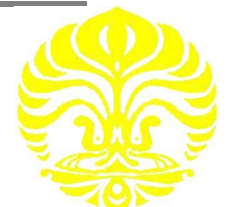

Cellular Network Organization

- Areas divided into cells
 - Each served by its own antenna(s)
 - Band of frequencies allocated
 - Cells set up such that antennas of all neighbors are equidistant (hexagonal pattern)
- Architecture
 - PSTN
 - MTSO
 - Base Station and Antenna

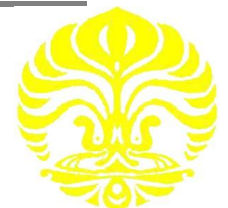

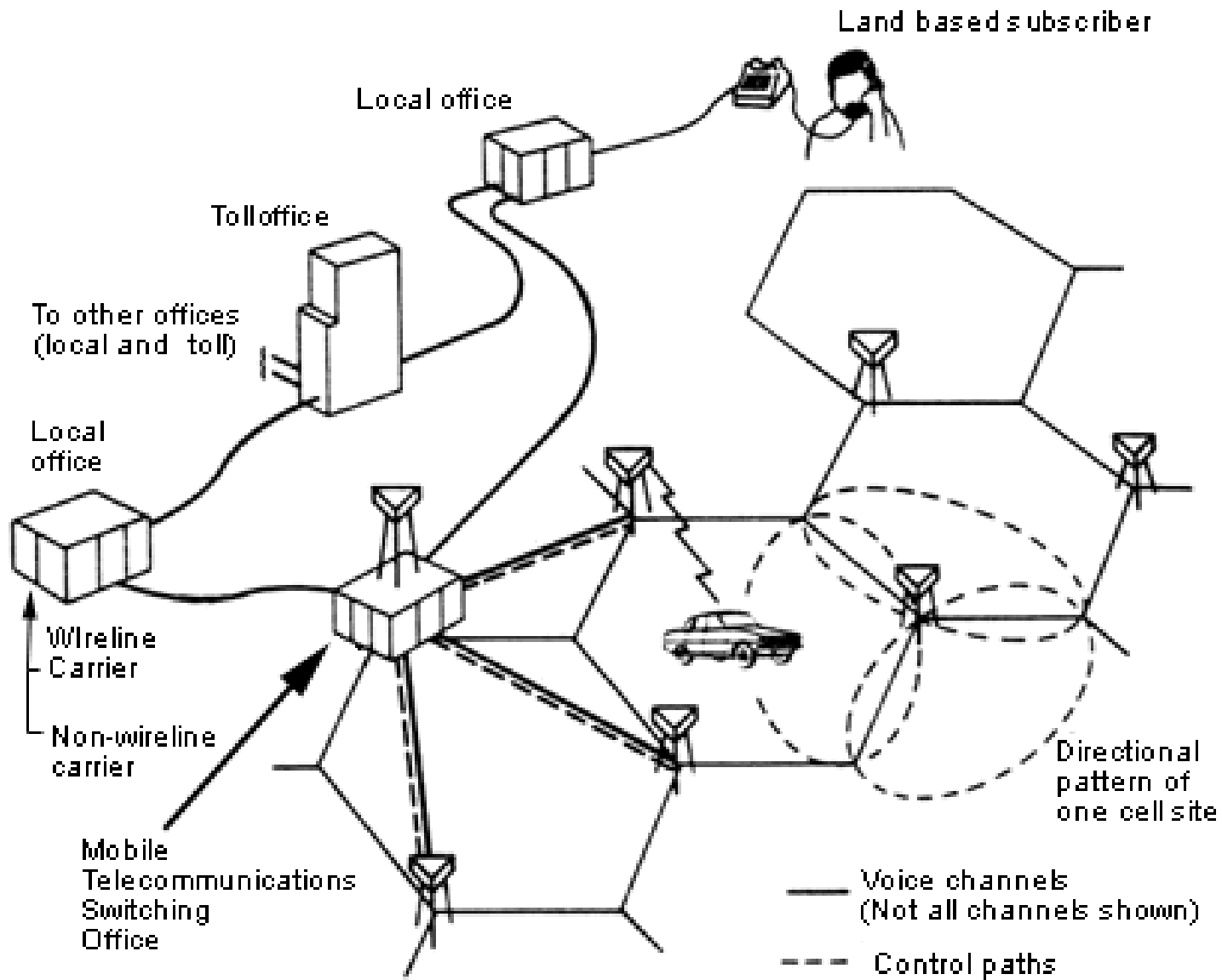

1984 Bell System Amps Plan, modified from the original

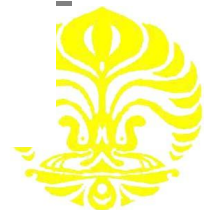

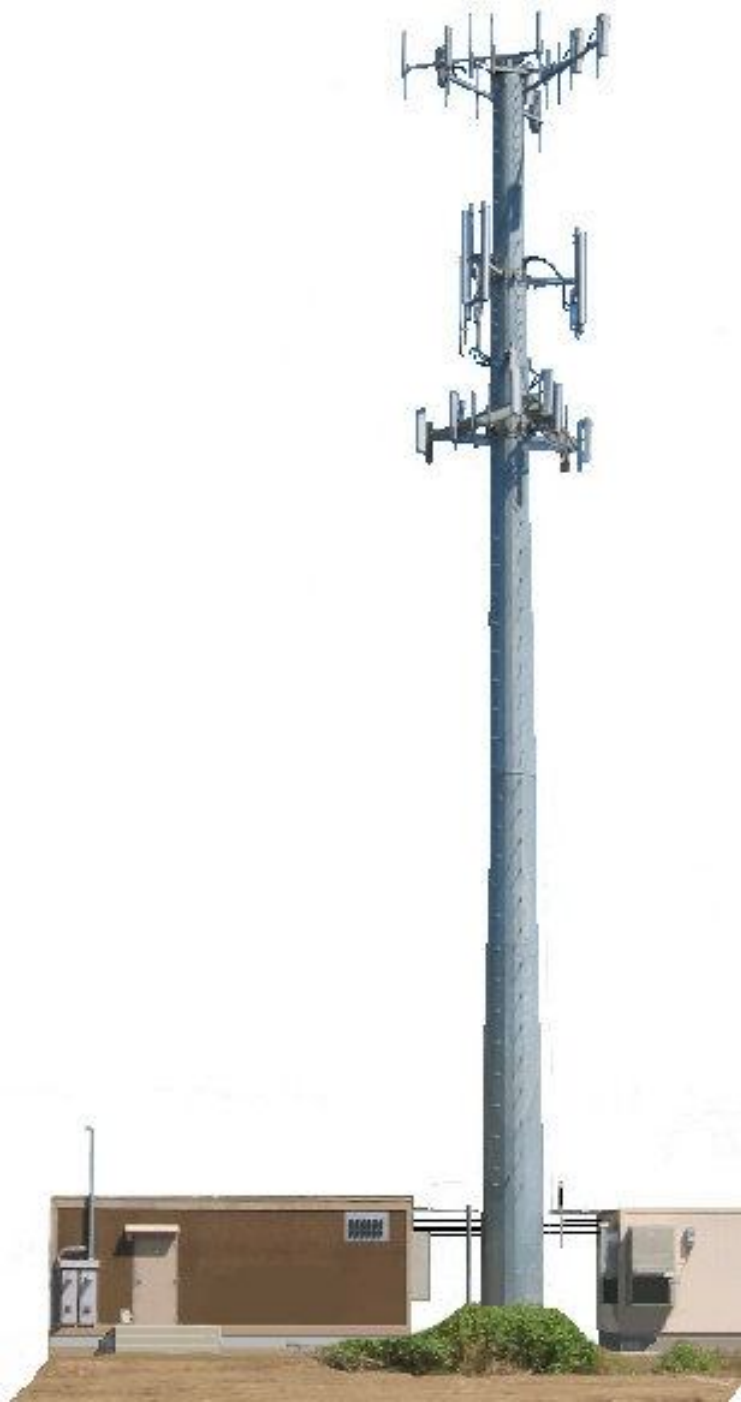

Slide 5

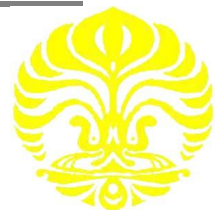

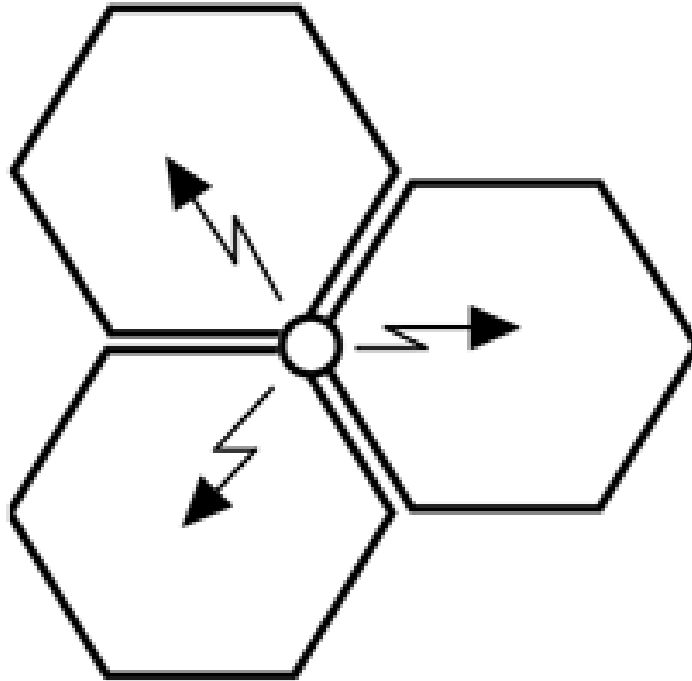

Right! 😊

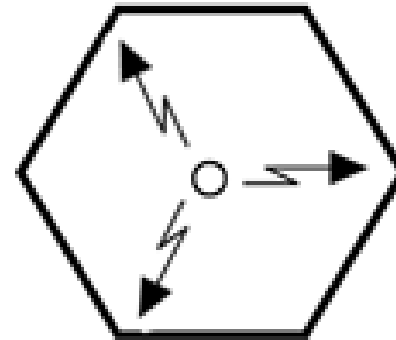

Wrong! 😞

— A cell site lies at the edge of several cells, not at the center. —

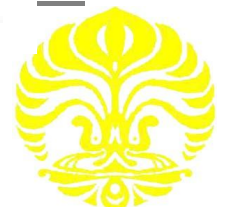

Frequency Reuse

- Adjacent cells assigned different frequencies to avoid interference or crosstalk
- Objective is to reuse frequency in nearby cells
 - 10 to 50 frequencies assigned to each cell
 - Transmission power controlled to limit power at that frequency escaping to adjacent cells
 - The issue is to determine how many cells must intervene between two cells using the same frequency

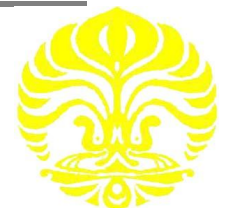

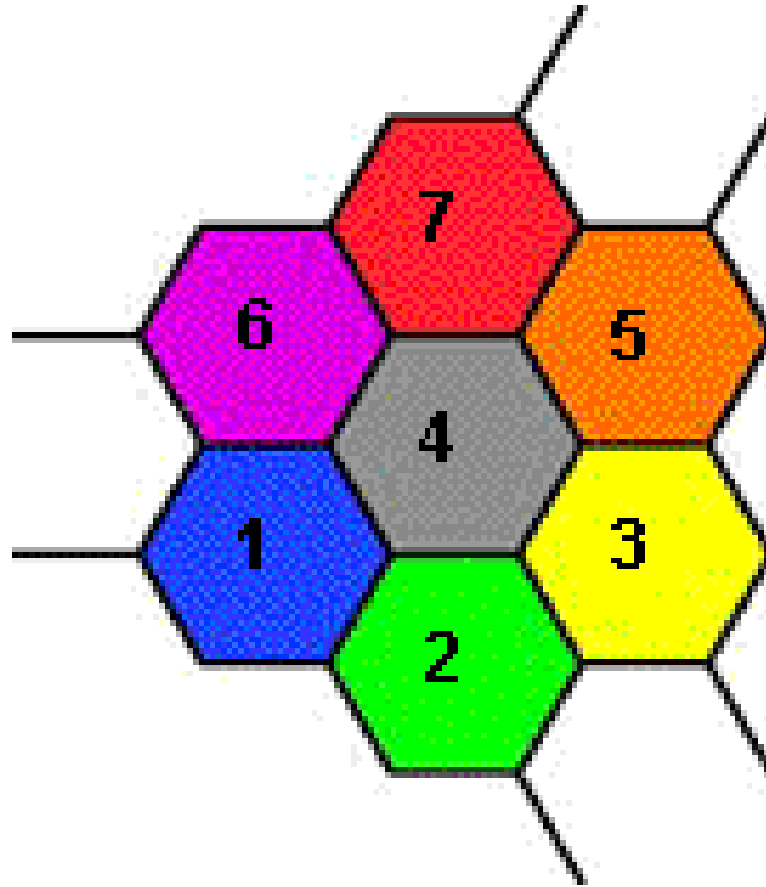

$N = 7$ (reuse factor)



Slide 8

Page 285

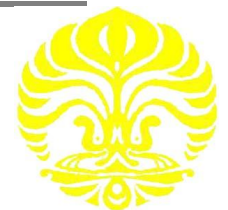

Approaches to Cope with Increasing Capacity

- Adding new channels
- Frequency borrowing – frequencies are taken from adjacent cells by congested cells
- Cell splitting – cells in areas of high usage can be split into smaller cells
- Cell sectoring – cells are divided into a number of wedge-shaped sectors, each with their own set of channels
- Microcells – antennas move to buildings, hills, and lamp posts

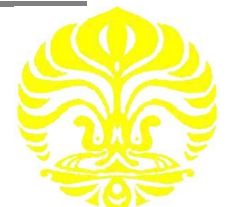

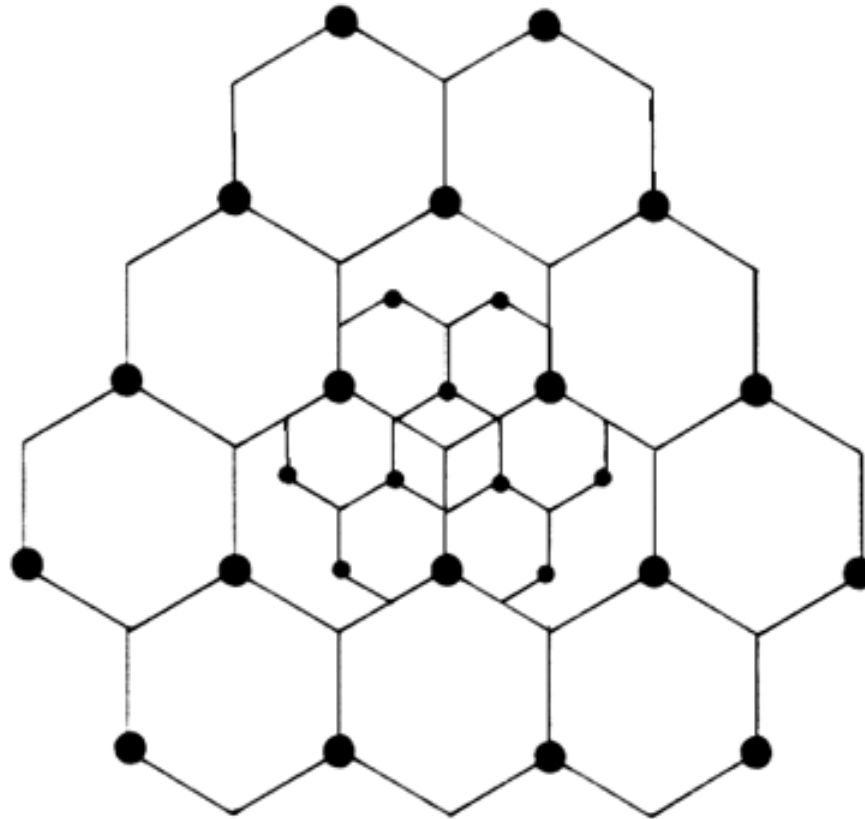
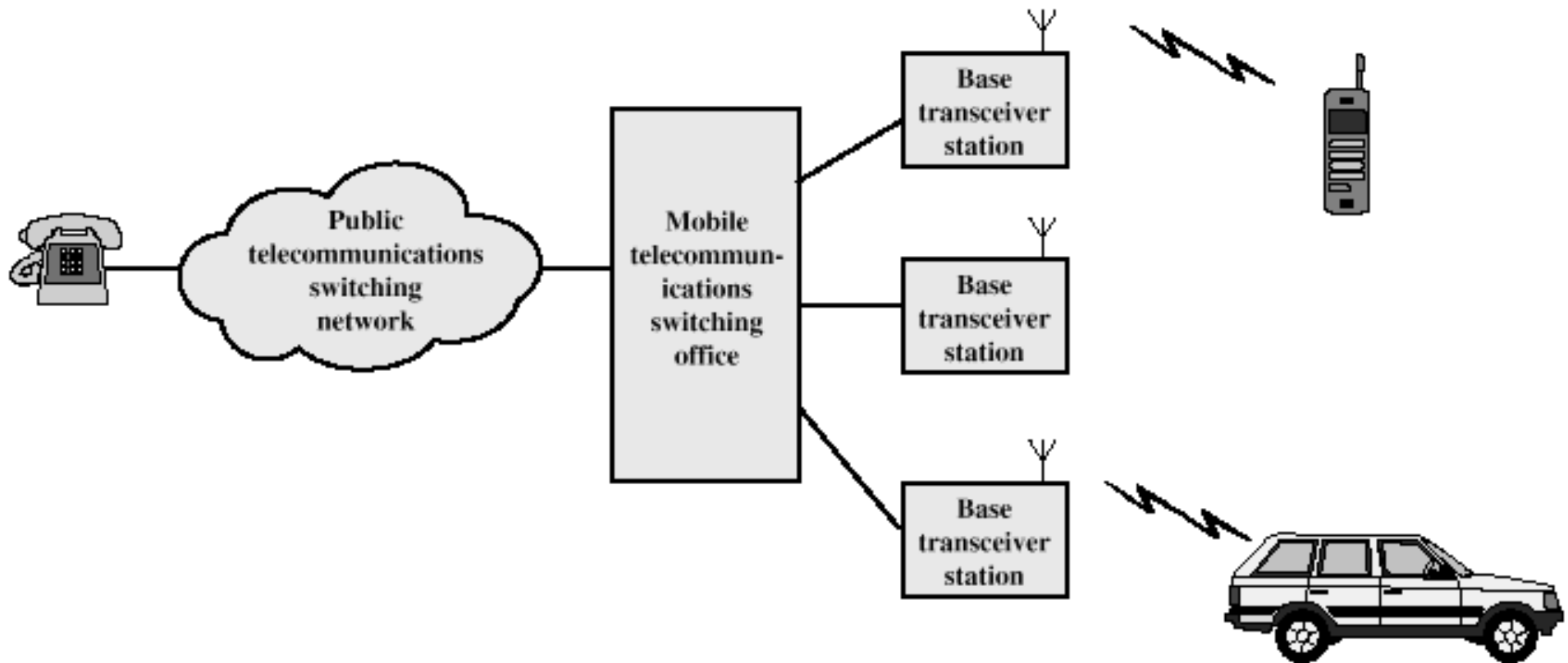
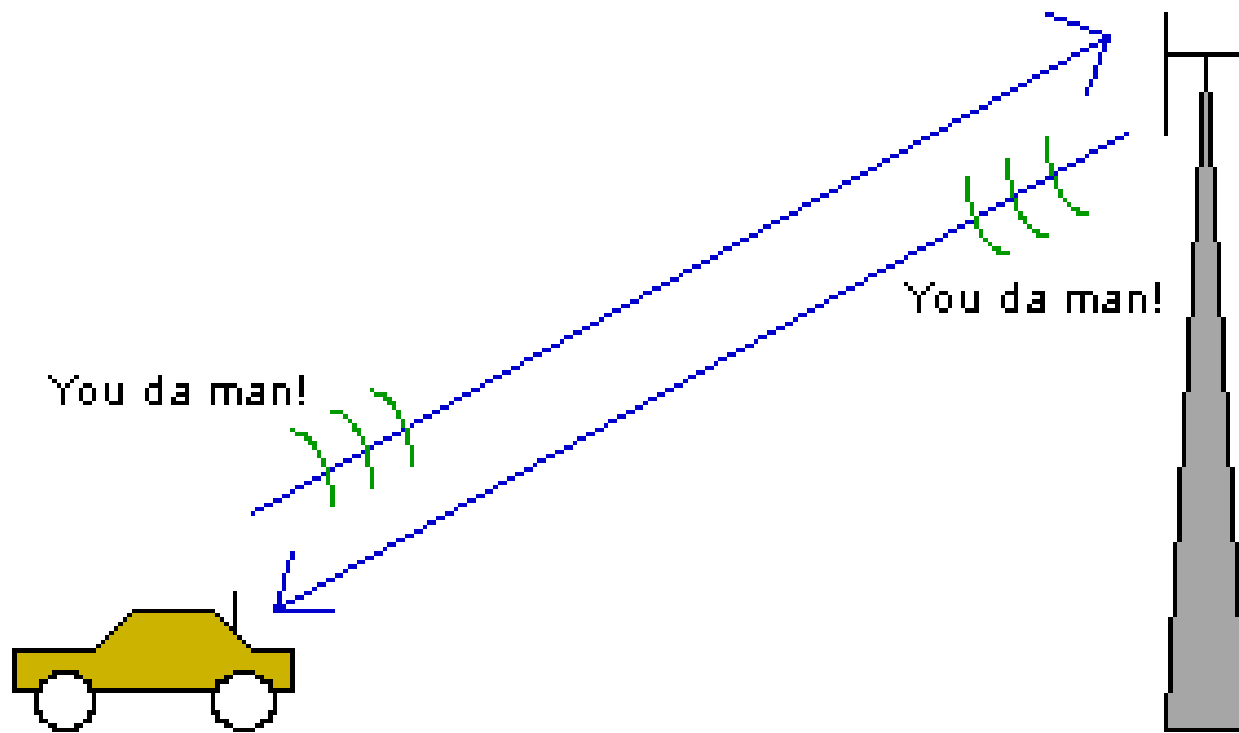

Figure 11-36. Staged growth of a Western Electric *AUTOPLEX* cellular radio system. (*AUTOPLEX* is a trademark of Western Electric.) Cell splitting, by adding new cell sites in areas of high demand, creates more traffic capacity.

Cellular System Overview





Cellular Systems Terms

- Base Station (BS) – includes an antenna, a controller, and a number of receivers
- Mobile telecommunications switching office (MTSO) – connects calls between mobile units
- Two types of channels available between mobile unit and BS
 - Control channels – used to exchange information having to do with setting up and maintaining calls
 - Traffic channels – carry voice or data connection between users

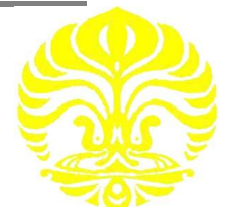

Steps in an MTSO Controlled Call between Mobile Users

- Mobile unit initialization
- Mobile-originated call
- Paging
- Call accepted
- Ongoing call
- Handoff

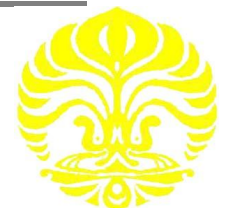

The MTSO

GETTING A CALL WITH A MOBILE PHONE

6 The MTSO checks out the information by itself and with network resources . . .

7 It begins monitoring for incoming calls to the mobile if the information checks out . . .

8 ALERT! INCOMING CALL FOR MR. MOBILE!

9 The switch sends a paging message out to all cell sites . . .

14 The MTSO picks a voice channel for the conversation and sends that assignment to the cell site . . .

The Cell Site

1 The cell site constantly transmits identifying information or *overhead* on its forward control channel . . .

5 The cell site gets that info and relays it to the MTSO . . .

10 Each cell site in the system sends a digital paging message for the mobile on the forward control channel . . .

13 Takes the digital message and sends it in the proper form to the MTSO . . .

15 The base station sends a digital message conveying the channel assignment to the mobile on the forward control path while . . .

The Mobile

2 Meanwhile, the mobile is turned on . . .

3 It scans the forward control channels (FCCs), searching for the one with the strongest signal . . .

4 The mobile locks on to the strongest channel and then transmits identifying information to the cell site on the reverse control channel or path . . .

In the meantime, the mobile idles, waiting for an incoming call by monitoring the control, setup or paging channel.

11 The mobile gets the page and confirms it by . . .

12 Seizing the control channel and sending a service request to the MTSO, letting the switch know that the mobile is turned on and not *off hook* or in use . . .

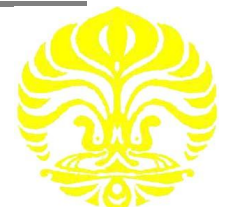

The MTSO

The Cell Site

The Mobile

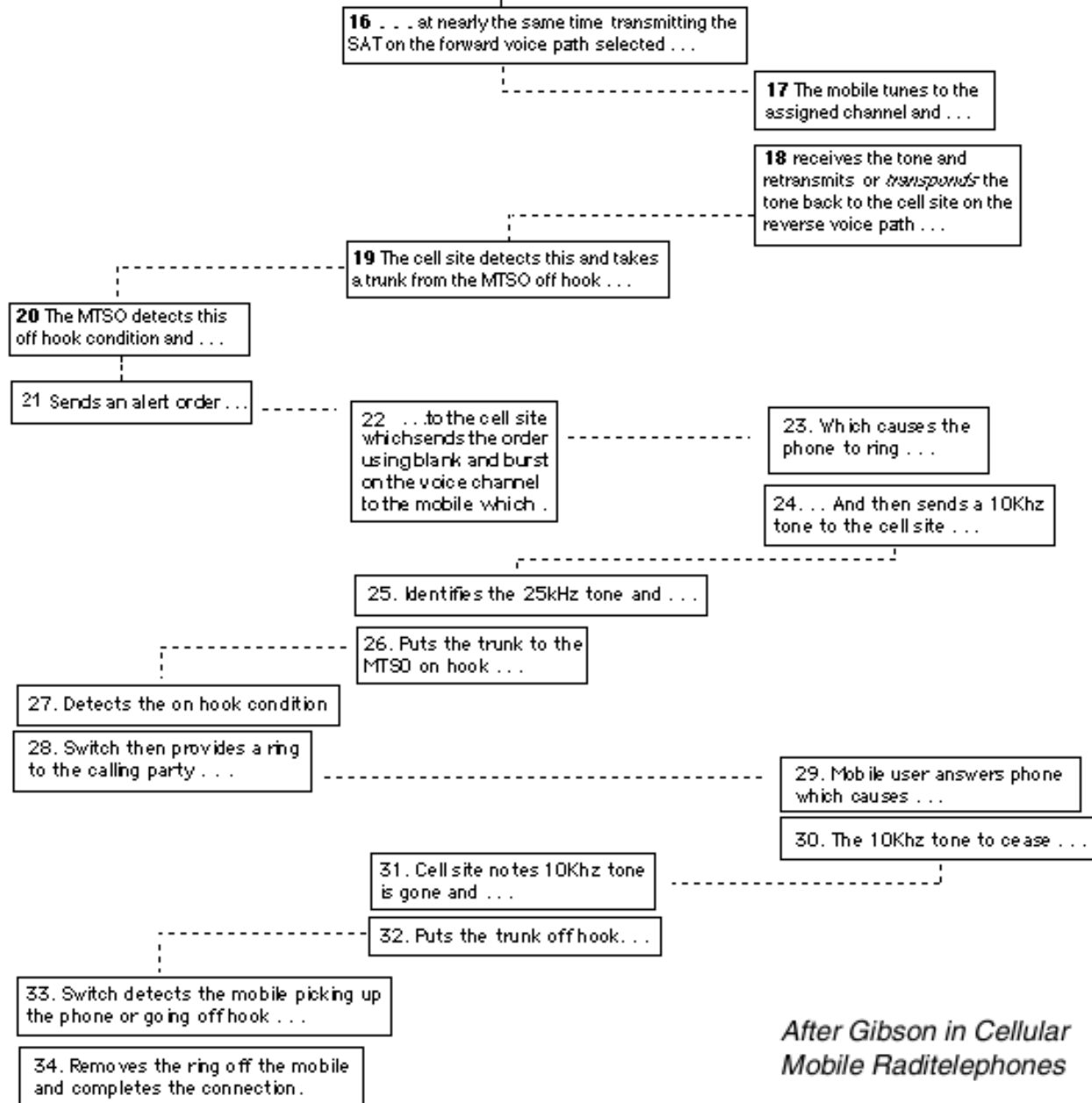

*After Gibson in Cellular
Mobile Raditelephones*



Additional Functions in an MTSO Controlled Call

- Call blocking
- Call termination
- Call drop
- Calls to/from fixed and remote mobile subscriber

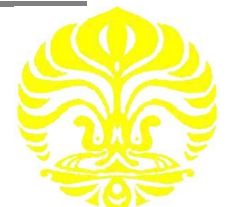

Mobile Radio Propagation Effects

- Signal strength
 - Must be strong enough between base station and mobile unit to maintain signal quality at the receiver
 - Must not be so strong as to create too much cochannel interference with channels in another cell using the same frequency band
- Fading
 - Signal propagation effects may disrupt the signal and cause errors

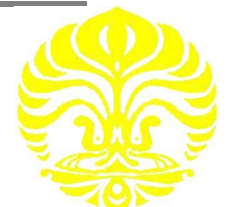

Handoff Performance Metrics

- Cell blocking probability – probability of a new call being blocked
- Call dropping probability – probability that a call is terminated due to a handoff
- Call completion probability – probability that an admitted call is not dropped before it terminates
- Probability of unsuccessful handoff – probability that a handoff is executed while the reception conditions are inadequate

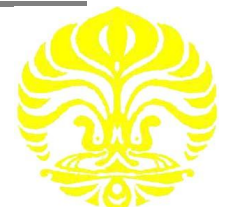

Handoff Performance Metrics

- Handoff blocking probability – probability that a handoff cannot be successfully completed
- Handoff probability – probability that a handoff occurs before call termination
- Rate of handoff – number of handoffs per unit time
- Interruption duration – duration of time during a handoff in which a mobile is not connected to either base station
- Handoff delay – distance the mobile moves from the point at which the handoff should occur to the point at which it does occur

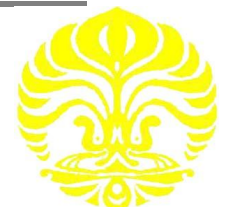

Handoff Strategies Used to Determine Instant of Handoff

- Relative signal strength
- Relative signal strength with threshold
- Relative signal strength with hysteresis
- Relative signal strength with hysteresis and threshold
- Prediction techniques

Page 294-295



Slide 21

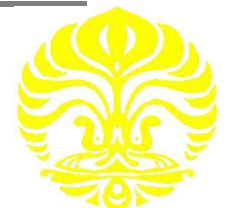

Power Control

- Design issues making it desirable to include dynamic power control in a cellular system
 - Received power must be sufficiently above the background noise for effective communication
 - Desirable to minimize power in the transmitted signal from the mobile
 - Reduce cochannel interference, alleviate health concerns, save battery power
 - In SS systems using CDMA, it's desirable to equalize the received power level from all mobile units at the BS

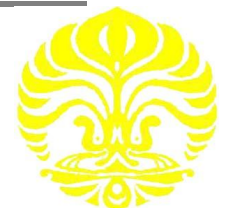

Types of Power Control

- Open-loop power control
 - Depends solely on mobile unit
 - No feedback from BS
 - Not as accurate as closed-loop, but can react quicker to fluctuations in signal strength
- Closed-loop power control
 - Adjusts signal strength in reverse channel based on metric of performance
 - BS makes power adjustment decision and communicates to mobile on control channel

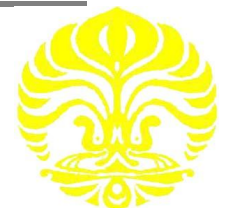

Traffic Engineering

- Ideally, available channels would equal number of subscribers active at one time
- In practice, not feasible to have capacity handle all possible load
- For N simultaneous user capacity and L subscribers
 - $L < N$ – nonblocking system (Non- Profit!)
 - $L > N$ – blocking system

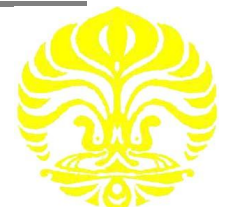

Blocking System Performance Questions

- Probability that call request is blocked?
- What capacity is needed to achieve a certain upper bound on probability of blocking?
- What is the average delay?
- What capacity is needed to achieve a certain average delay?



Traffic Intensity

- Load presented to a system:
 - λ = mean rate of calls attempted per unit time
 - h = mean holding time per successful call
 - $A = \lambda h$ = average number of calls arriving during average holding period, for normalized λ

Problem 5!

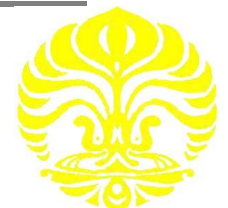

Factors that Determine the Nature of the Traffic Model

- Manner in which blocked calls are handled
 - Lost calls delayed (LCD) – blocked calls put in a queue awaiting a free channel
 - Blocked calls rejected and dropped
 - Lost calls cleared (LCC) – user waits before another attempt
 - Lost calls held (LCH) – user repeatedly attempts calling
- Number of traffic sources
 - Whether number of users is assumed to be finite or infinite

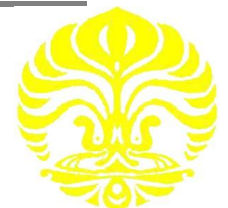

First-Generation Analog

- Advanced Mobile Phone Service (AMPS)
 - In North America, two 25-MHz bands allocated to AMPS (pg 304)
 - One for transmission from base to mobile unit
 - One for transmission from mobile unit to base
 - Each band split in two to encourage competition
 - Frequency reuse exploited
- Each carrier could support
 - 395 / 2 voice calls per cell
 - 21 control channels (10kbps)
 - Required creative splitting of busy cells!

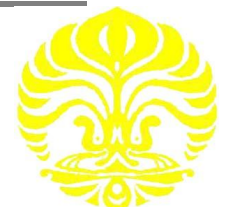

AMPS Operation – 1G

- Subscriber initiates call by keying in phone number and presses send key
- MTSO verifies number and authorizes user
- MTSO issues message to user's cell phone indicating send and receive traffic channels
- MTSO sends ringing signal to called party
- Party answers; MTSO establishes circuit and initiates billing information
- Either party hangs up; MTSO releases circuit, frees channels, completes billing

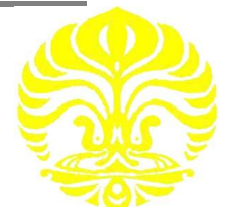

Differences Between First and Second Generation Systems

- Digital traffic channels – first-generation systems are almost purely analog; second-generation systems are digital
- Encryption – all second generation systems provide encryption to prevent eavesdropping
- Error detection and correction – second-generation digital traffic allows for detection and correction, giving clear voice reception (digital / dsp)
- Channel access – second-generation systems allow channels to be dynamically shared by a number of users (TDM and CDMA)



AMPS Frequency reuse

- Mobile station transmission frequencies
 - 824.04 ~ 848.97 MHz
- Base stations transmission frequencies
 - 869.04 ~ 893.97 MHz
- 45 MHz separation between transmit and receive channels
- AMPS uses 832 channels that are each 30 kHz wide

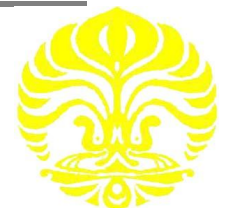

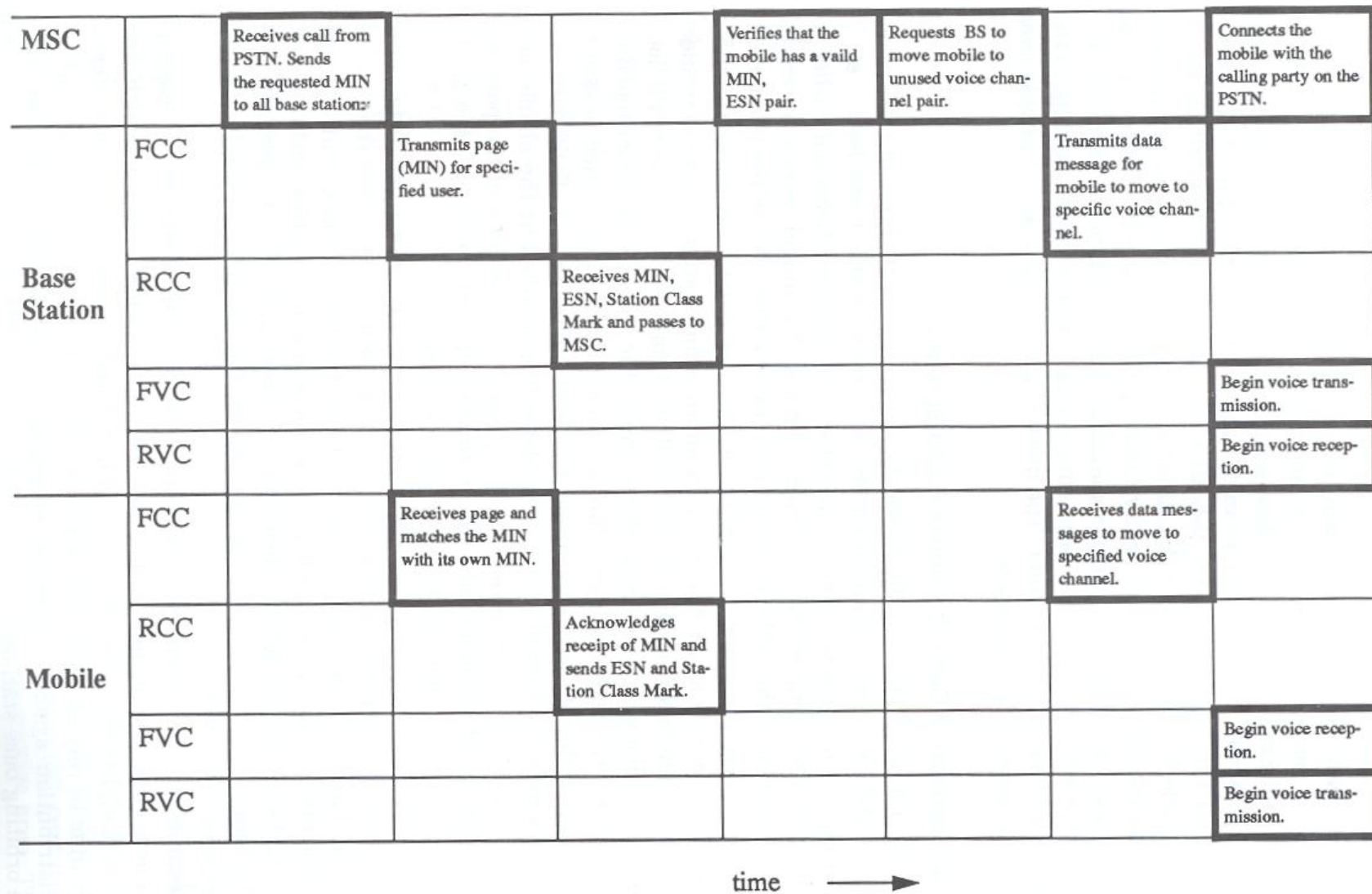
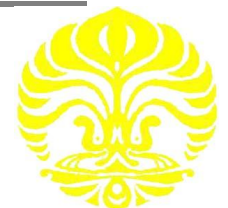

Figure 1.6

Timing diagram illustrating how a call to a mobile user initiated by a landline subscriber is established.

2G and Beyond - Standards

- Purposes – Allow interoperation of equipment
- Allows many vendors to compete
- Less risk for implementers
- Based on technologies (from ch2-8)



2G - TDMA Basics

- Used TDM with FDM (same 30kHz channels)
- TD multiplexed 3 users per channel
- Voice encoding
 - PCM is 64kbps – TOO BIG
 - Used technique to make 12kbps
- Cingular and many ATT phones use this!

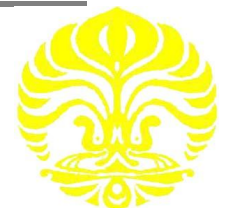

Voice Coding Algorithms

Algorithm	Rate (kb/s)	MOS /5		MIPS
PCM (G.711)	64	4.3	.01	
ADPCM (G.721)	32	4.1		2
LD-CELP (G.728)	16	4	19	
RPE-LTP (GSM)	13	3.47		6
Skyphone-MPLP	9.6	3.4		11
VSELP (IS-54)	8	3.45		13.5
CELP (IS-95)	4.8	3.2	16	

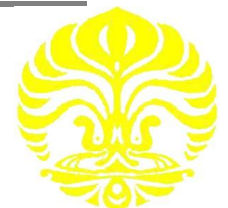

TDMA - Design Considerations

- Number of logical channels (number of time slots in TDMA frame): 8
- Maximum cell radius (R): 35 km
- Frequency: region around 900 MHz
- Maximum vehicle speed (V_m): 250 km/hr
- Maximum coding delay: approx. 20 ms
- Maximum delay spread (Δ_m): 10 μ s
- Bandwidth: Not to exceed 200 kHz (25 kHz per channel)

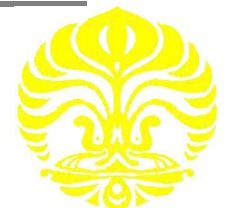

2G- GSM

- Uses TDMA with 8 users per channel
- Based on European standards
- T-Mobile!

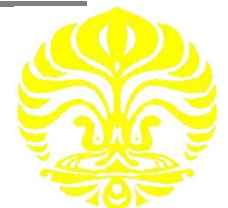

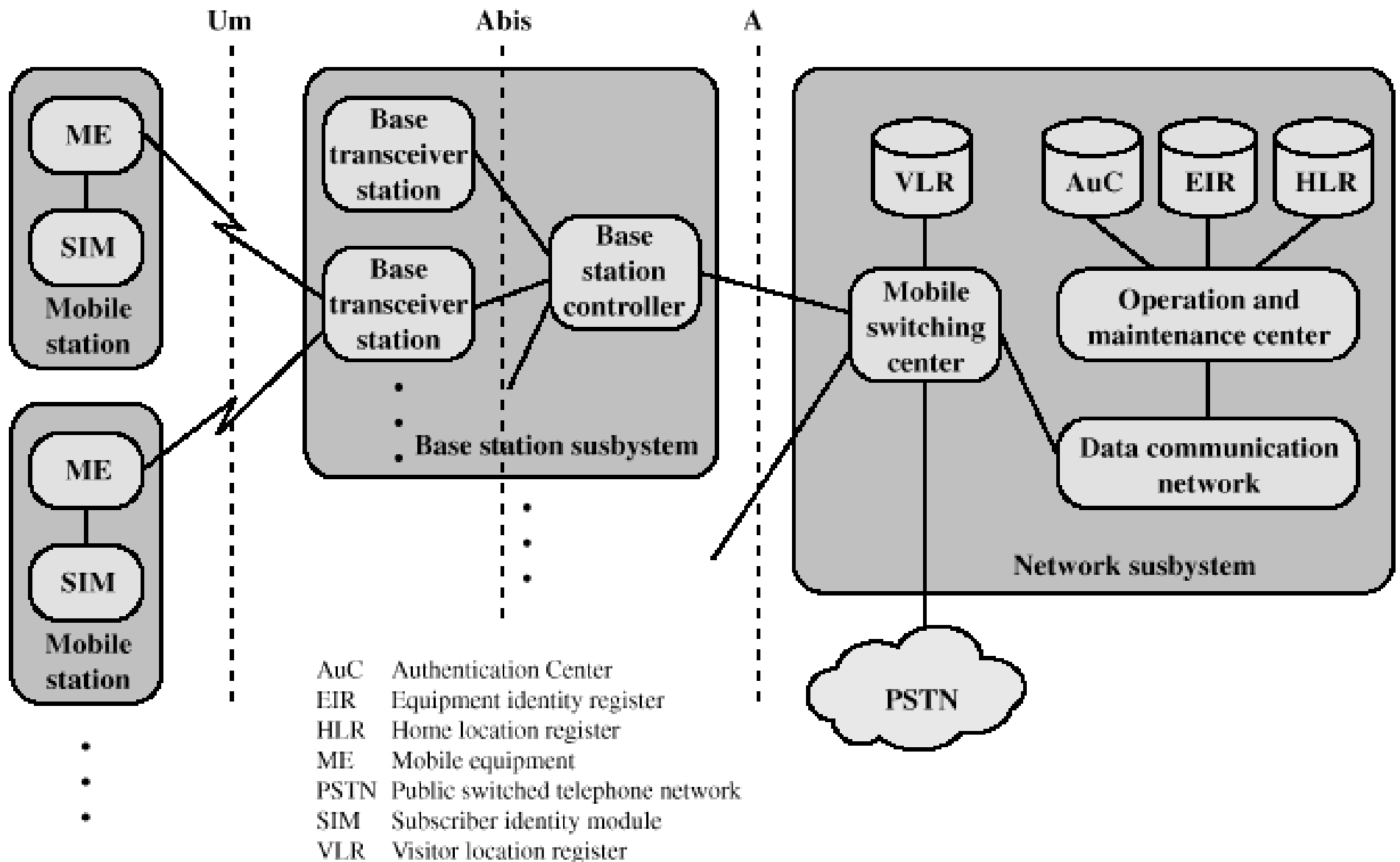
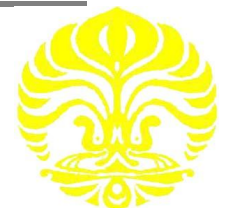

Figure 10.14 Overall GSM Architecture

Mobile Station

- Mobile station communicates across Um interface (air interface) with base station transceiver in same cell as mobile unit
- Mobile equipment (ME) – physical terminal, such as a telephone or PCS
 - ME includes radio transceiver, digital signal processors and subscriber identity module (SIM)
- GSM subscriber units are generic until SIM is inserted
 - SIMs roam, not necessarily the subscriber devices



Base Station Subsystem (BSS)

- BSS consists of base station controller and one or more base transceiver stations (BTS)
- Each BTS defines a single cell
 - Includes radio antenna, radio transceiver and a link to a base station controller (BSC)
- BSC reserves radio frequencies, manages handoff of mobile unit from one cell to another within BSS, and controls paging

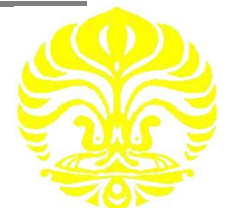

Network Subsystem (NS)

- NS provides link between cellular network and public switched telecommunications networks
 - Controls handoffs between cells in different BSSs
 - Authenticates users and validates accounts
 - Enables worldwide roaming of mobile users
- Central element of NS is the mobile switching center (MSC)

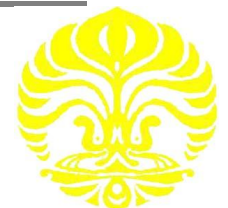

Mobile Switching Center (MSC) Databases

- Home location register (HLR) database – stores information about each subscriber that belongs to it
- Visitor location register (VLR) database – maintains information about subscribers currently physically in the region
- Authentication center database (AuC) – used for authentication activities, holds encryption keys
- Equipment identity register database (EIR) – keeps track of the type of equipment that exists at the mobile station

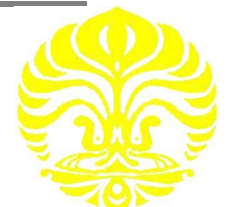

TDMA Format – Time Slot Fields

- Trail bits – allow synchronization of transmissions from mobile units
- Encrypted bits – encrypted data
- Stealing bit - indicates whether block contains data or is "stolen"
- Training sequence – used to adapt parameters of receiver to the current path propagation characteristics
 - Strongest signal selected in case of multipath propagation
- Guard bits – used to avoid overlapping with other bursts

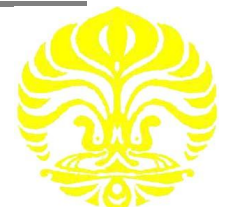

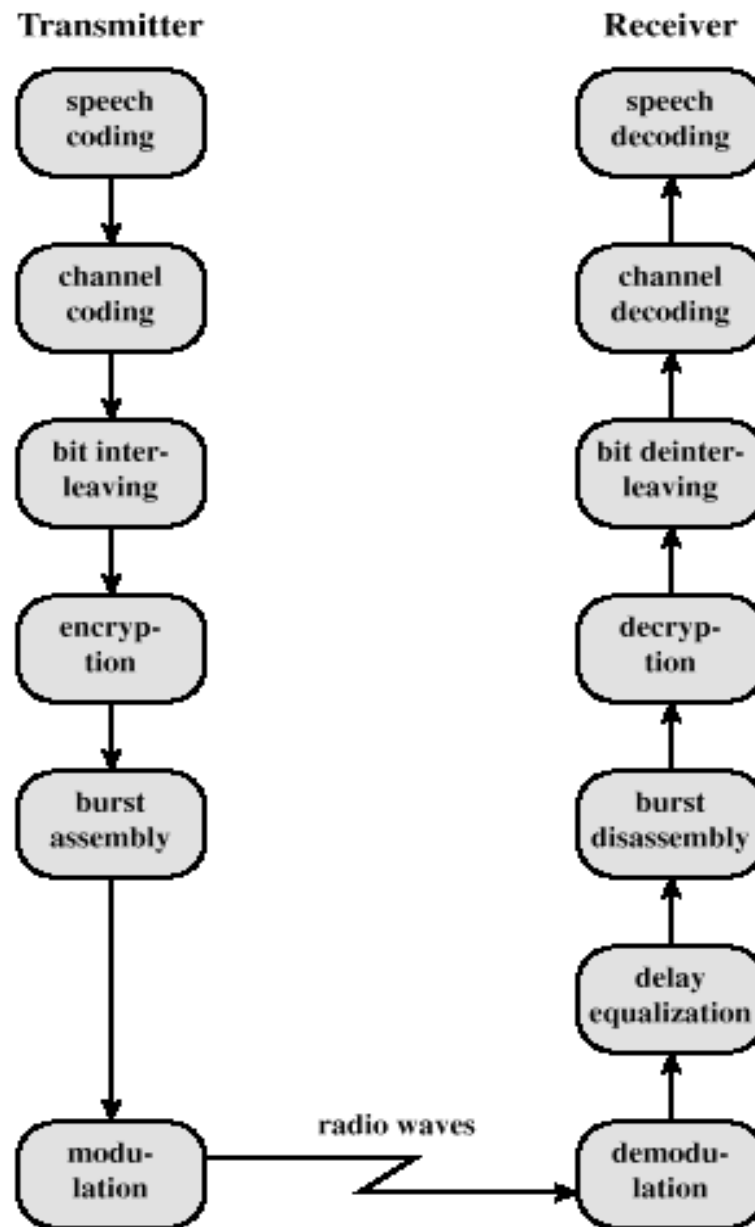
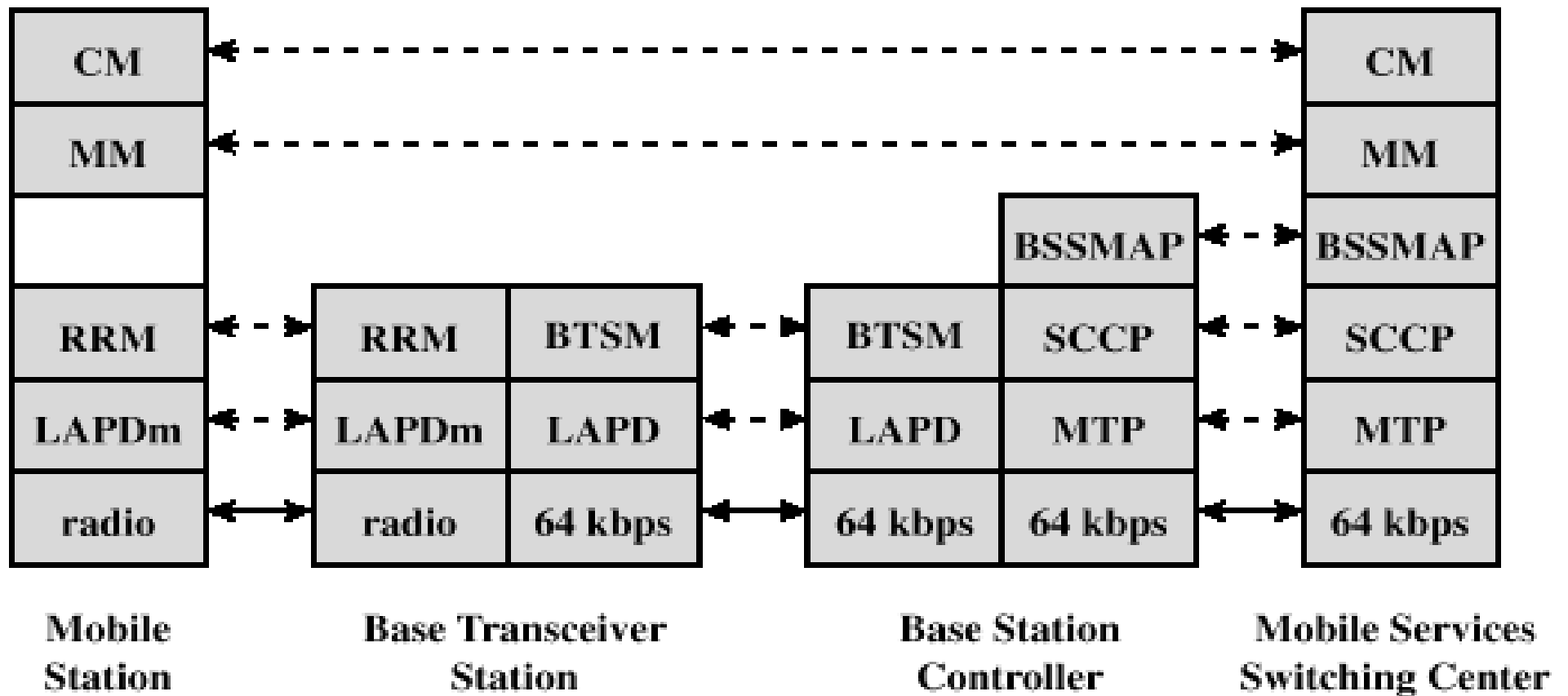

Figure 10.16 GSM Speech Signal Processing





BSSMAP = BSS mobile application part
 BTSM = BTS management
 CM = connection management
 LAPD = link access protocol, D channel

MM = mobility management
 MTP = message transfer part
 RRM = radio resources management
 SCCP = signal connection control part

Figure 10.17 GSM Signaling Protocol Architecture

Functions Provided by Protocols

- Protocols above the link layer of the GSM signaling protocol architecture provide specific functions:
 - Radio resource management
 - Mobility management
 - Connection management
 - Mobile application part (MAP)
 - BTS management

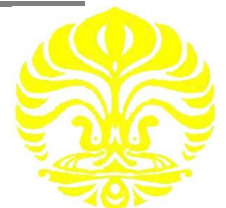

2G – CDMA - Advantages

- Frequency diversity – frequency-dependent transmission impairments have less effect on signal
- Multipath resistance – chipping codes used for CDMA exhibit low cross correlation and low autocorrelation
- Privacy – privacy is inherent since spread spectrum is obtained by use of noise-like signals
- Graceful degradation – system only gradually degrades as more users access the system

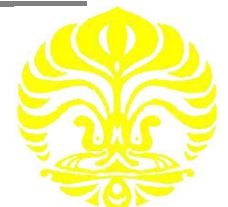

Drawbacks of CDMA Cellular

- Self-jamming – arriving transmissions from multiple users not aligned on chip boundaries unless users are perfectly synchronized
- Near-far problem – signals closer to the receiver are received with less attenuation than signals farther away
- Soft handoff – requires that the mobile acquires the new cell before it relinquishes the old; this is more complex than hard handoff used in FDMA and TDMA schemes

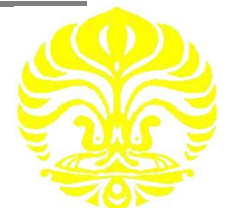

Mobile Wireless CDMA Design Considerations

- RAKE receiver – when multiple versions of a signal arrive more than one chip interval apart, RAKE receiver attempts to recover signals from multiple paths and combine them
 - This method achieves better performance than simply recovering dominant signal and treating remaining signals as noise
- Soft Handoff – mobile station temporarily connected to more than one base station simultaneously

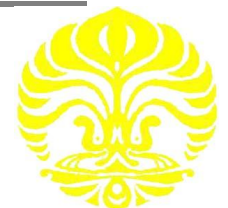

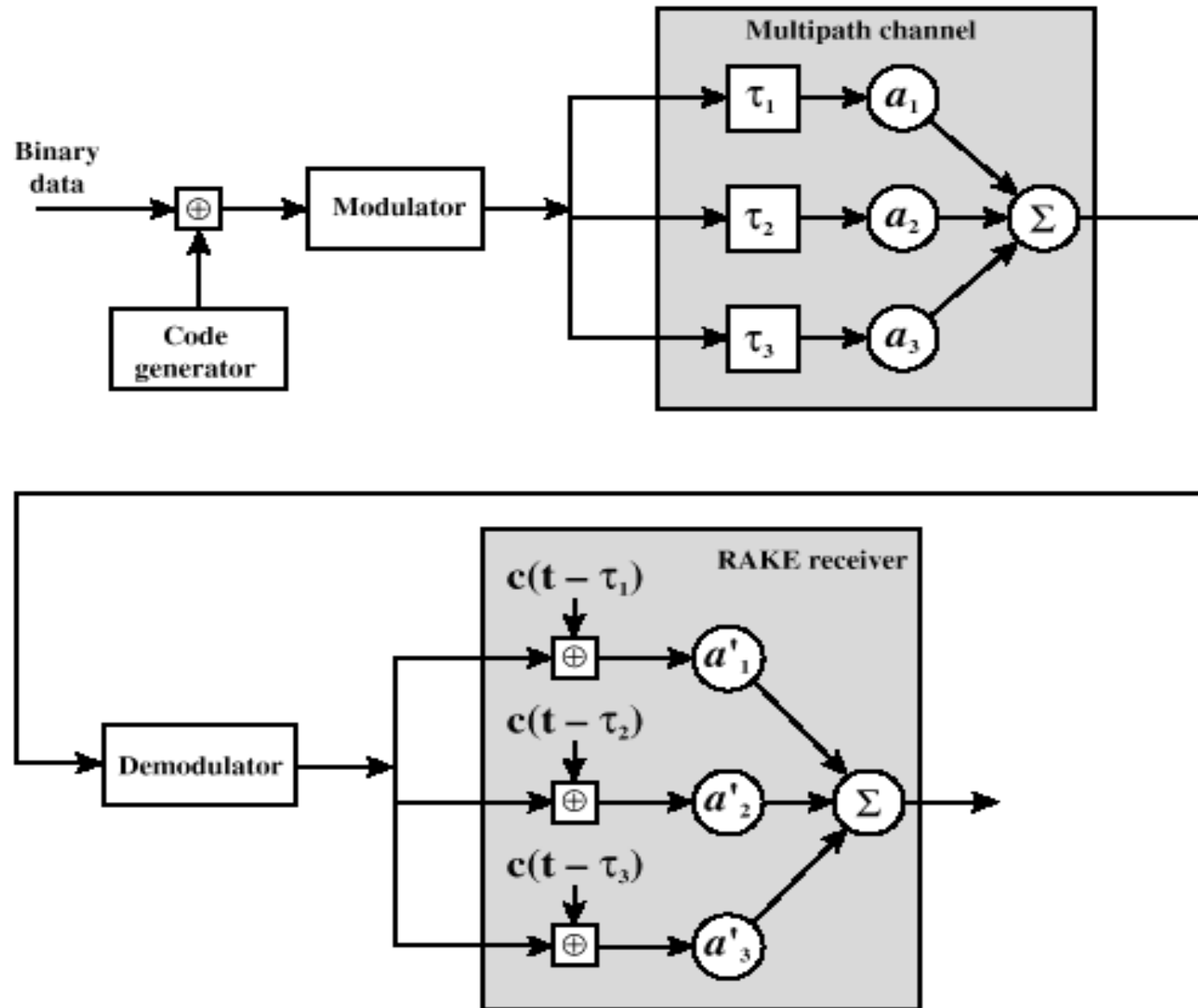

Figure 10.18 Principle of RAKE Receiver [PRAS98]



Types of Channels Supported by Forward Link (BS to Mobile)

- Pilot (channel 0) - allows the mobile unit to acquire timing information, provides phase reference and provides means for signal strength comparison
- Synchronization (channel 32) - used by mobile station to obtain identification information about cellular system
- Paging (channels 1 to 7) - contain messages for one or more mobile stations
- Traffic (channels 8 to 31 and 33 to 63) – the forward channel supports 55 traffic channels



Forward Traffic Channel Processing Steps (Fig 10.20)

- Speech is encoded at a rate of 8550 bps
- Additional bits added for error detection
- Data transmitted in 2-ms blocks with forward error correction provided by a convolution encoder
- Data interleaved in blocks to reduce effects of errors
- Data bits are scrambled, serving as a privacy mask

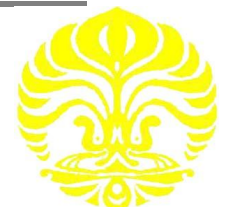

Forward traffic channel
information bits
(172, 80, 40, or 16 b/frame)

8.6 kbps
4.0 kbps
2.0 kbps
0.8 kbps

Add frame
quality indica-
tors for 9600 &
4800 bps rates

9.2 kbps
4.4 kbps
2.0 kbps
0.8 kbps

Add 8-bit
encoder tail

9.6 kbps
4.8 kbps
2.4 kbps
1.2 kbps

Convolutional
encoder
(n, k, K) = (2, 1, 9)

19.2 kbps
9.6 kbps
4.8 kbps
2.4 kbps

Code
symbol

Symbol
repetition

19.2 kbps

Code
symbol

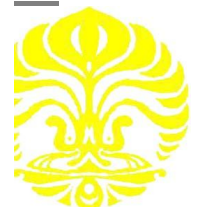
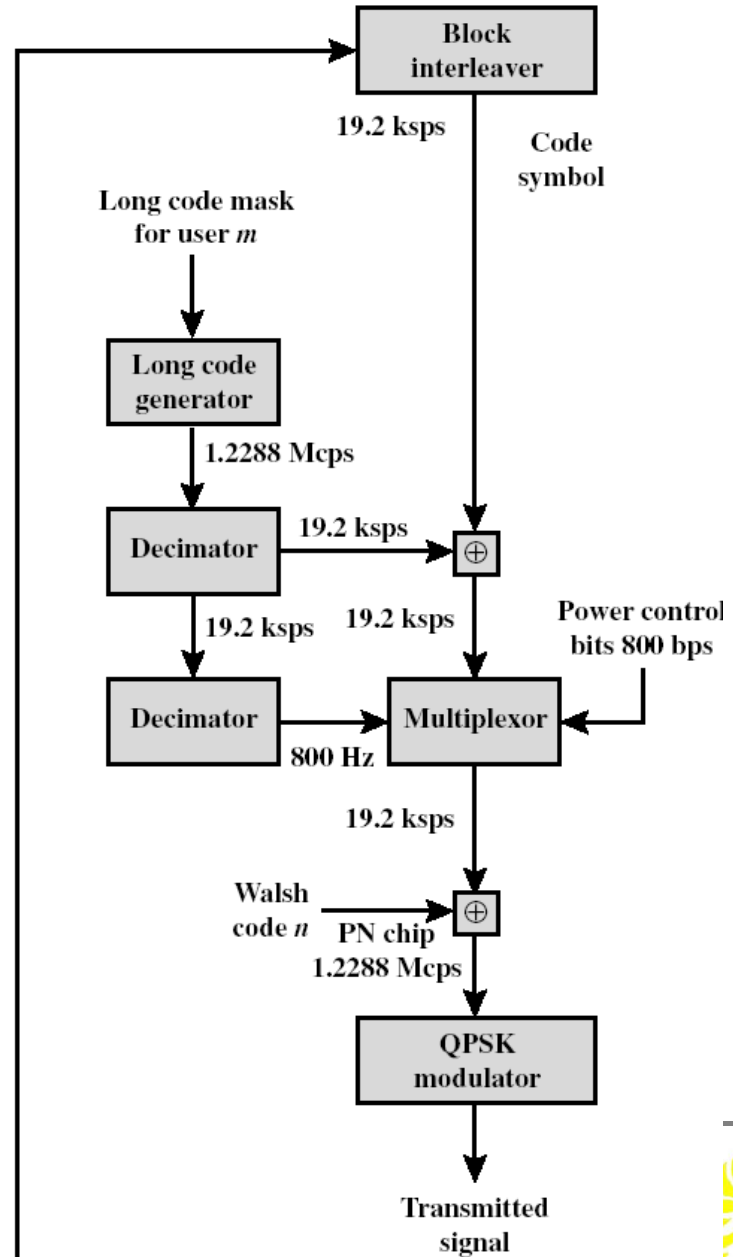

Forward Traffic Channel Processing Steps (cont.)

- Power control information inserted into traffic channel
- DS-SS function spreads the 19.2 kbps to a rate of 1.2288 Mbps using one row of 64 x 64 Walsh matrix
- Digital bit stream modulated onto the carrier using QPSK modulation scheme

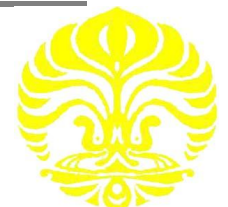

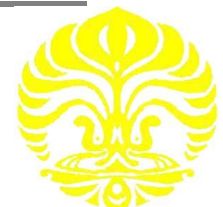
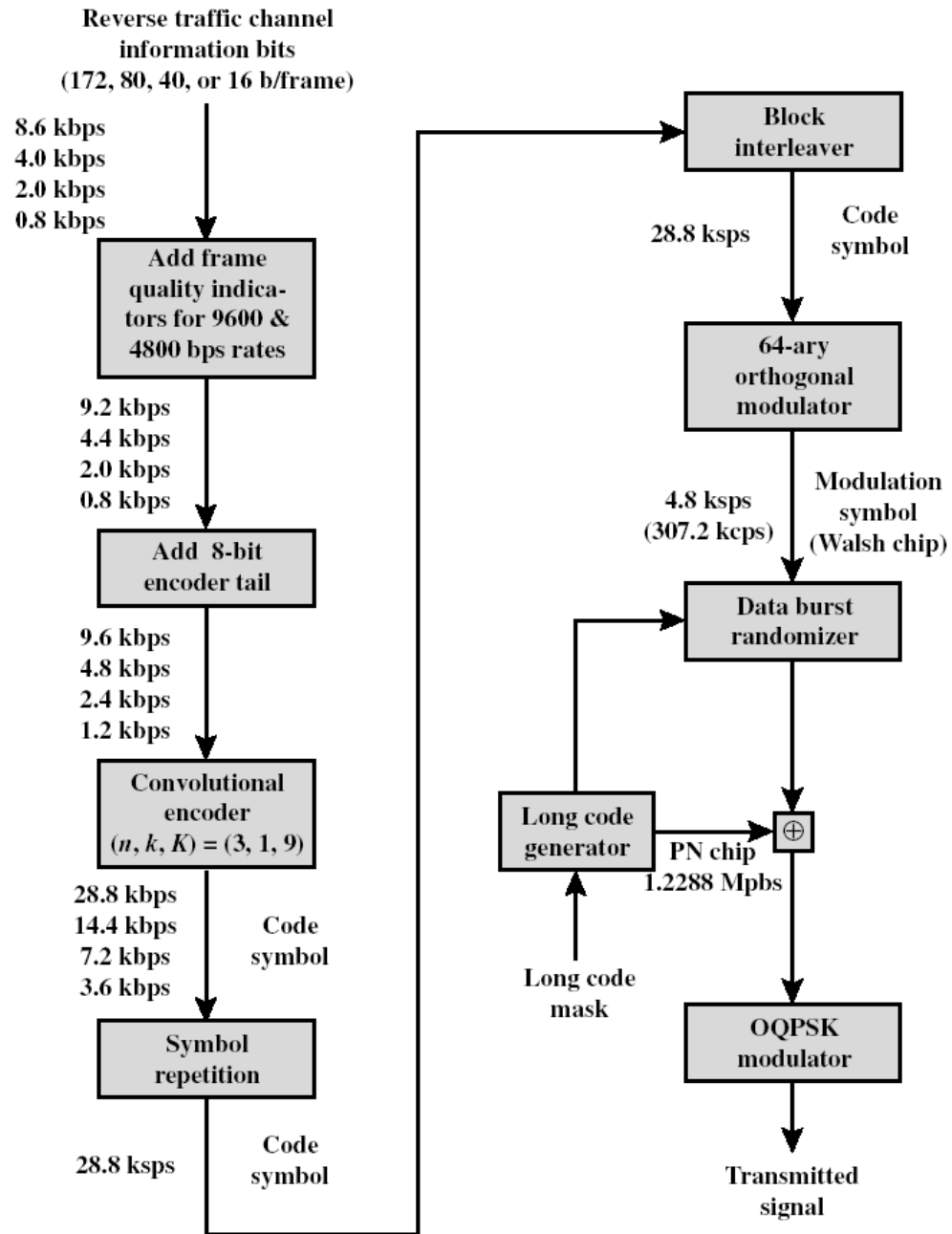

3G - ITU's View of Capabilities

- Voice quality comparable to the public switched telephone network
- 144 kbps data rate available to users in high-speed motor vehicles over large areas
- 384 kbps available to pedestrians standing or moving slowly over small areas
- Support for 2.048 Mbps for office use
- Symmetrical / asymmetrical data transmission rates
- Support for both packet switched and circuit switched data services

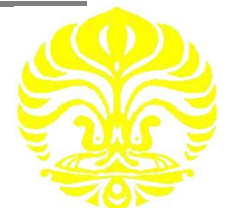

3G - ITU's View of Capabilities

- An adaptive interface to the Internet to reflect efficiently the common asymmetry between inbound and outbound traffic
- More efficient use of the available spectrum in general
- Support for a wide variety of mobile equipment
- Flexibility to allow the introduction of new services and technologies

BIG GOALS



Slide 57

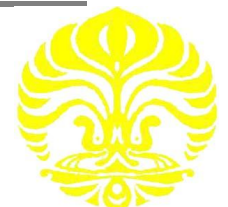

Alternative Interfaces

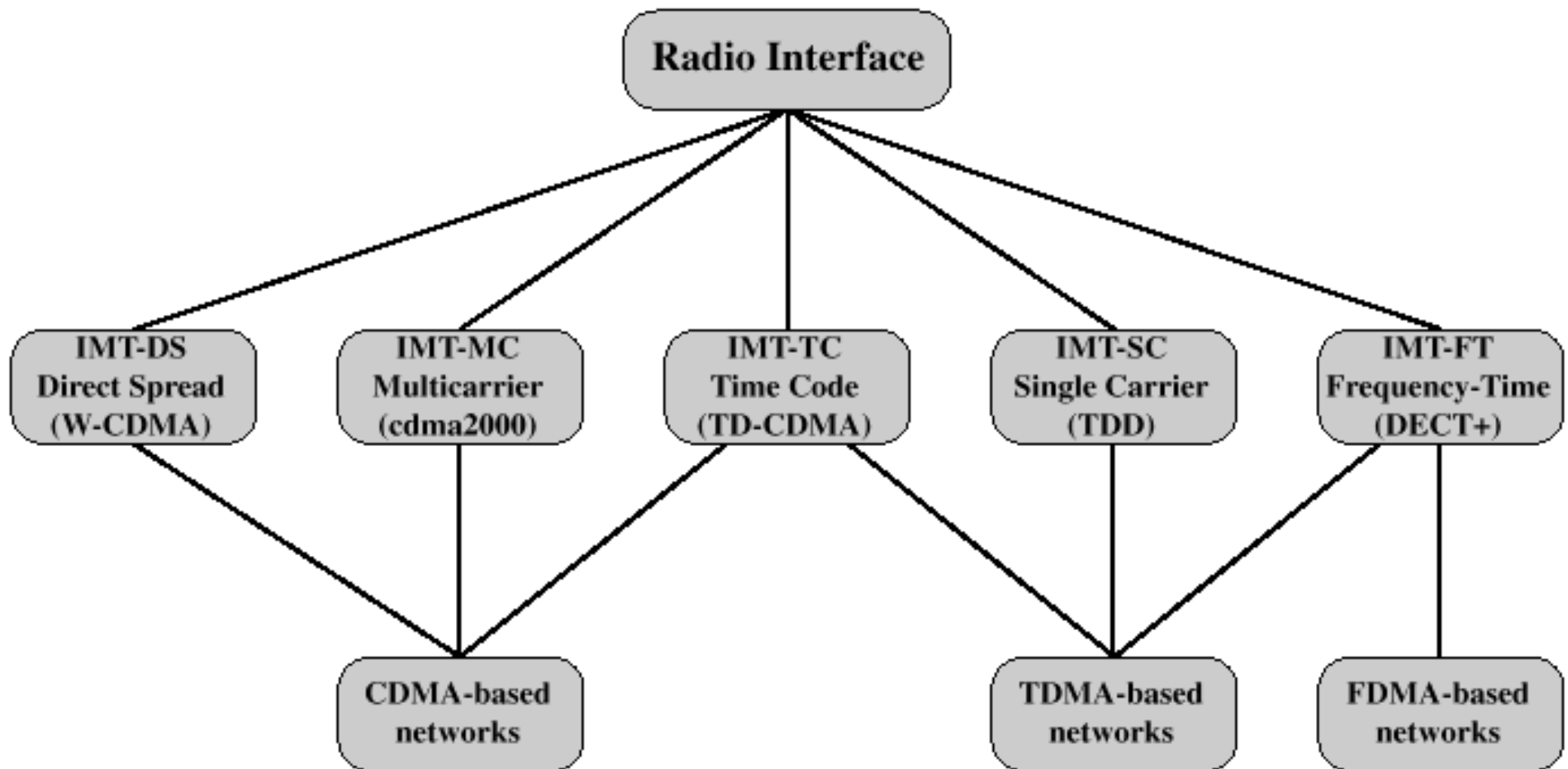

CDMA Design Considerations

- CDMA is dominant in 3G
- Bandwidth – limit channel usage to 5 MHz
- Chip rate – depends on desired data rate, need for error control, and bandwidth limitations; 3 Mcps or more is reasonable
- Multirate – advantage is that the system can flexibly support multiple simultaneous applications from a given user and can efficiently use available capacity by only providing the capacity required for each service

